

F U12 +40 kg

Budo Cup 2021

Tatami  
2 10:35

Pool  
1

(c)sportdata GmbH & Co KG 2000-2021(2021-10-23 18:31) -WKF Approved- v 9.8.7 build 3 (2020-09-25) License: Estonian Karate Federation (expire 2022-11-29)

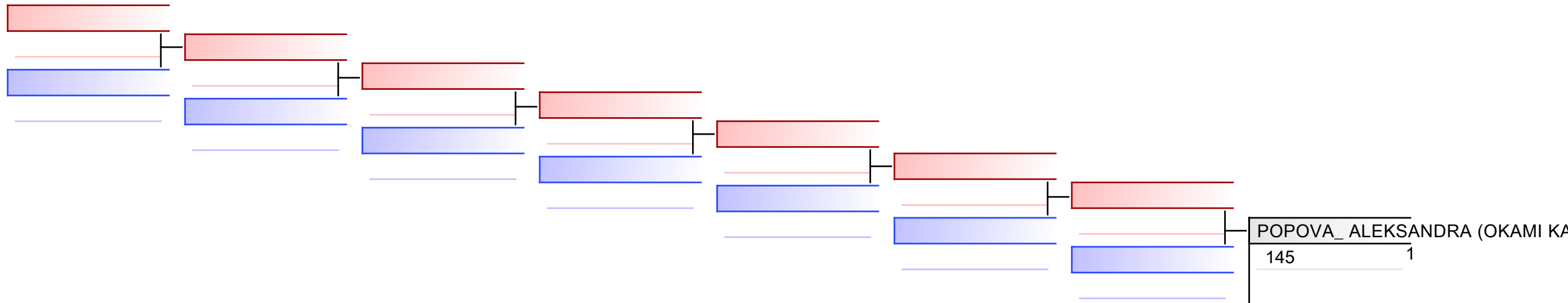

REPECHAGE: (1)

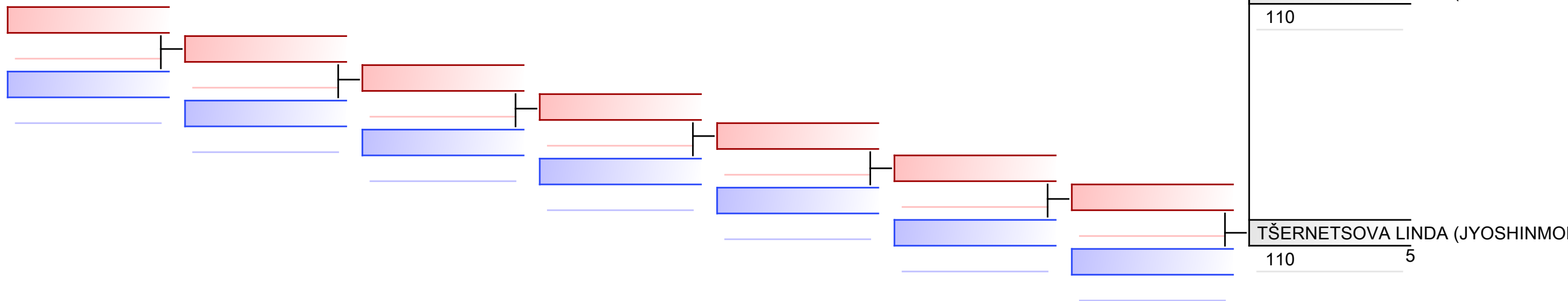

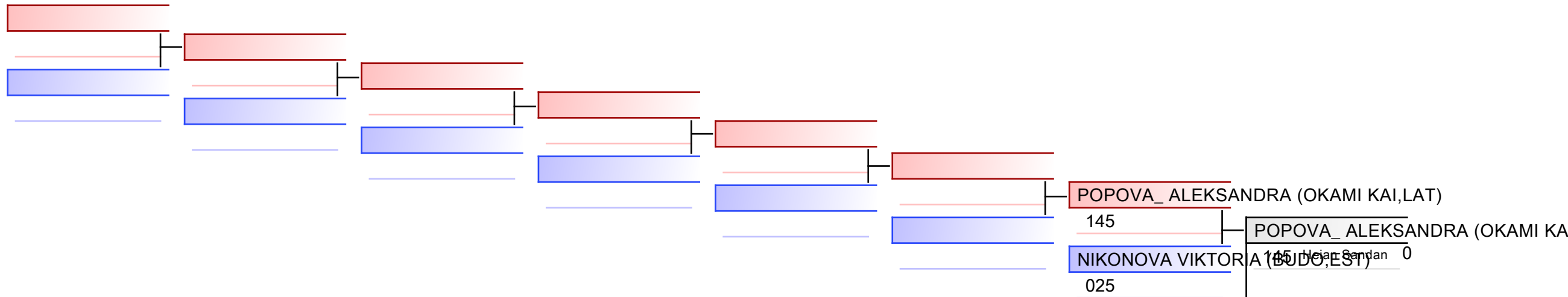

REPECHAGE: (1)

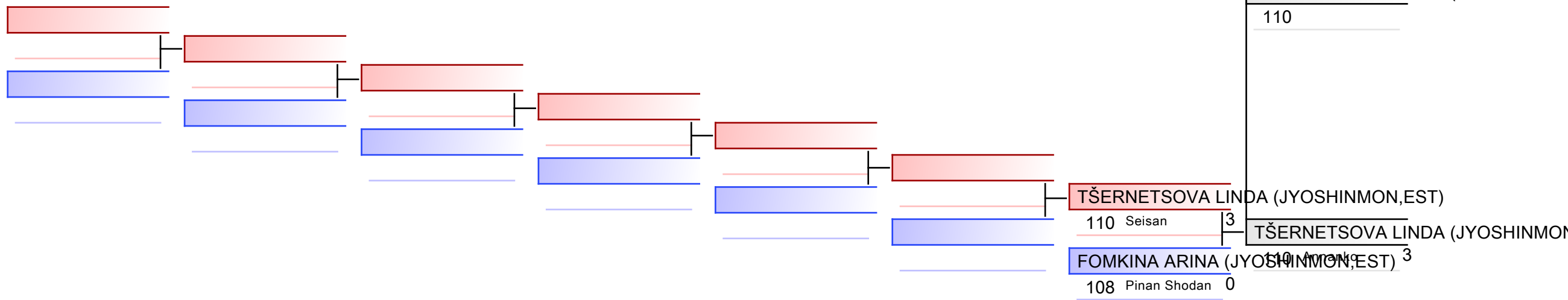

# F U14 +47 kg

Budo Cup 2021

Tatami  
1 12:05

Pool  
1

(c)sportdata GmbH & Co KG 2000-2021(2021-10-23 18:31) -WKF Approved- v 9.8.7 build 3 (2020-09-25) License: Estonian Karate Federation (expire 2022-11-29)

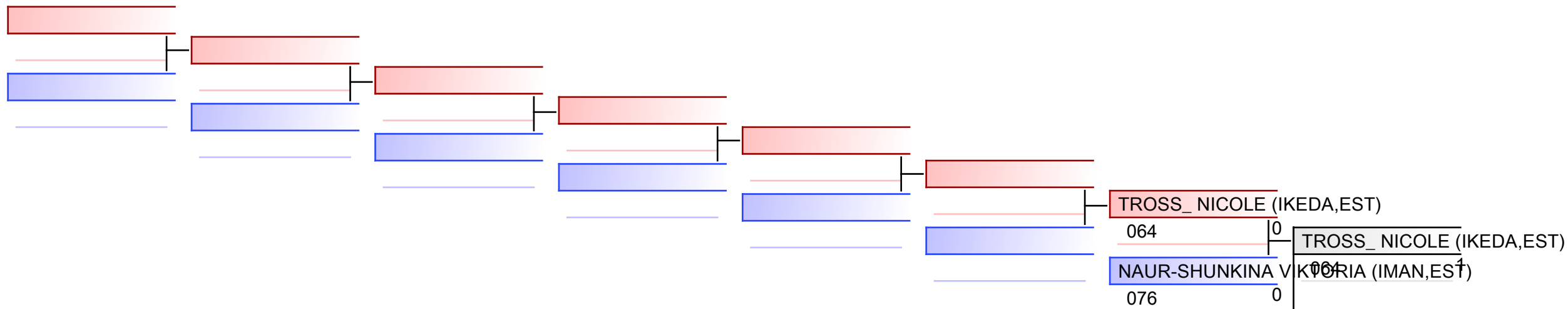

## REPECHAGE: (1)

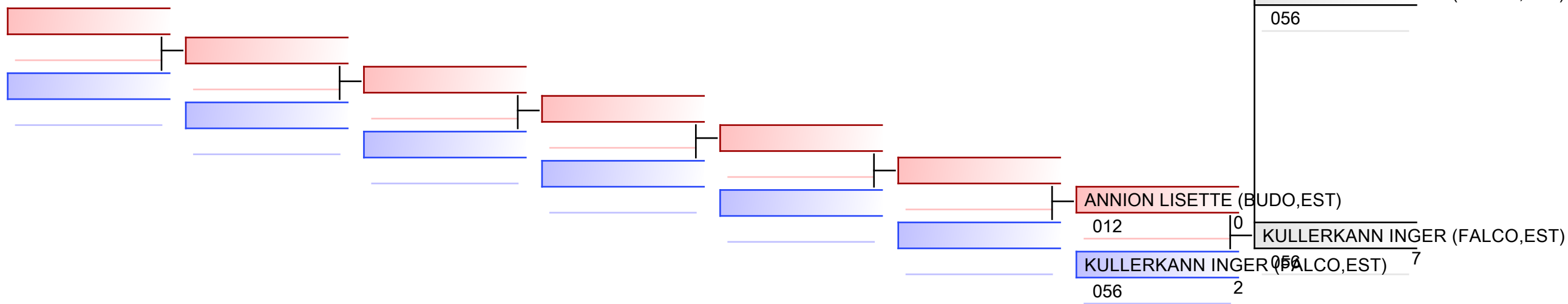

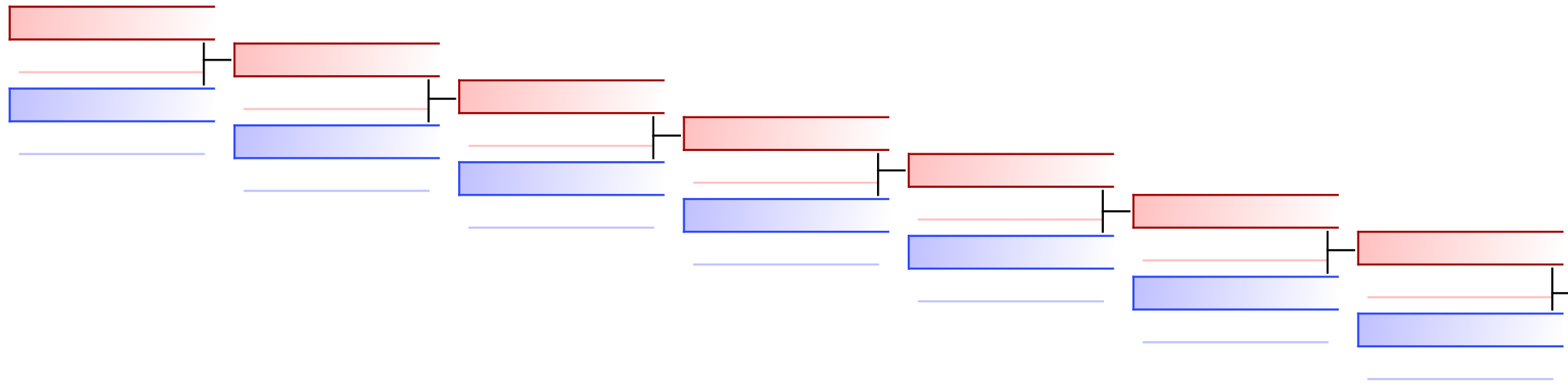

VASILJEVA ANGELINA (R.SADIKOV S)  
168 1

REPECHAGE: (1)

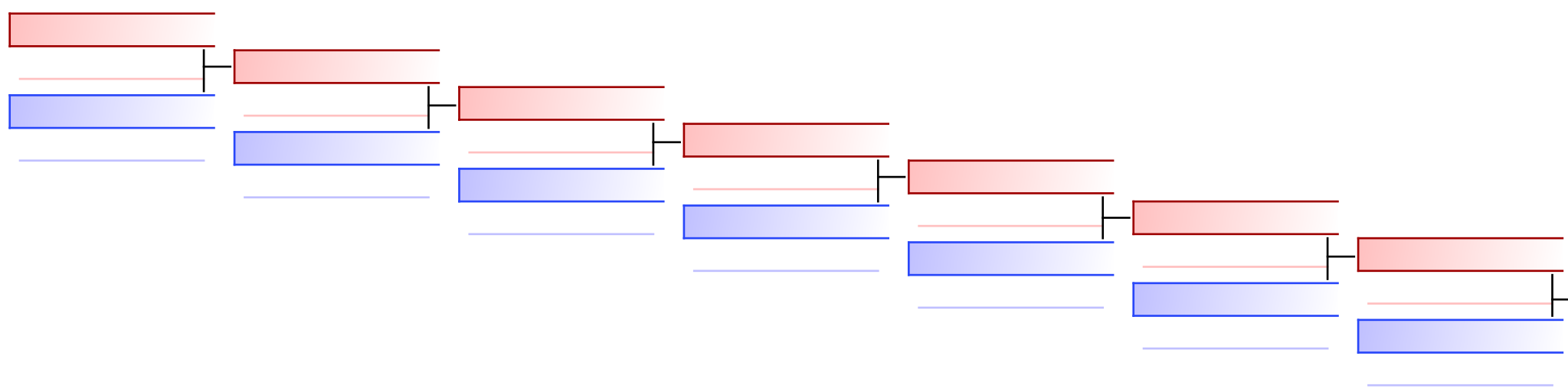

PIATROUSKAYA LALITA (VOLAT, BLF)  
008

PIATROUSKAYA LALITA (VOLAT, BLF)  
008 6

F U16 +54 kg

Budo Cup 2021

Tatami  
2 13:35

Pool  
1

(c)sportdata GmbH & Co KG 2000-2021(2021-10-23 18:31) -WKF Approved- v 9.8.7 build 3 (2020-09-25) License: Estonian Karate Federation (expire 2022-11-29)

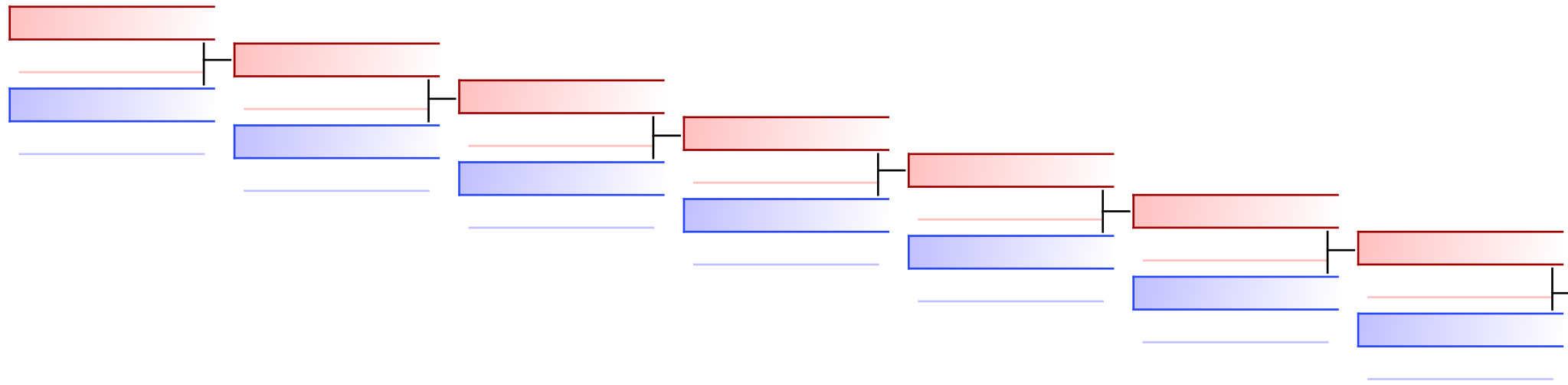

VARANKINAITE KAMILE (OKU KARATE)	
179	0

REPECHAGE: (1)

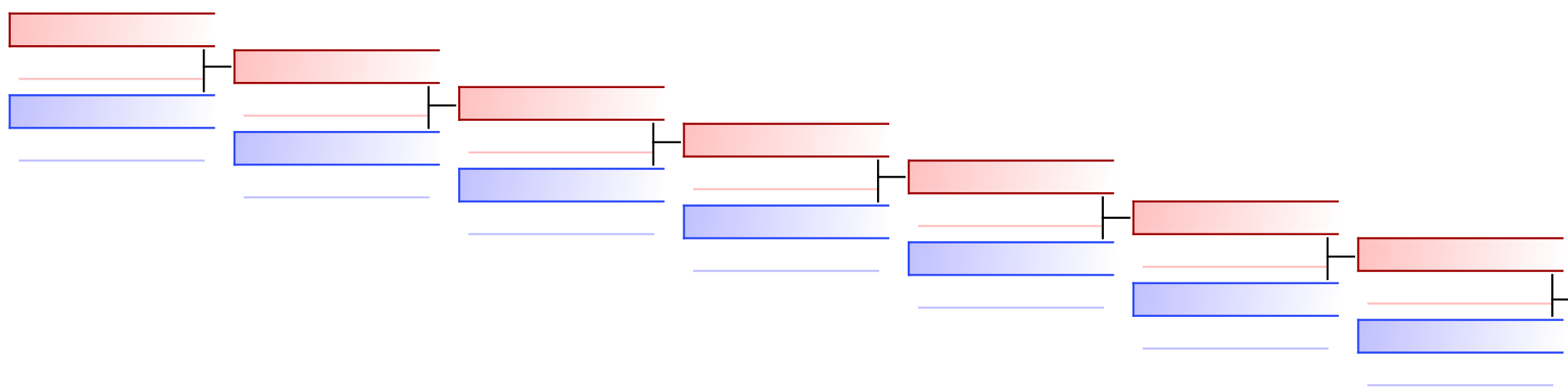

MAZUR ALESJA (JYOSHINMON,EST)	
109	

MAZUR ALESJA (JYOSHINMON,EST)	
109	5

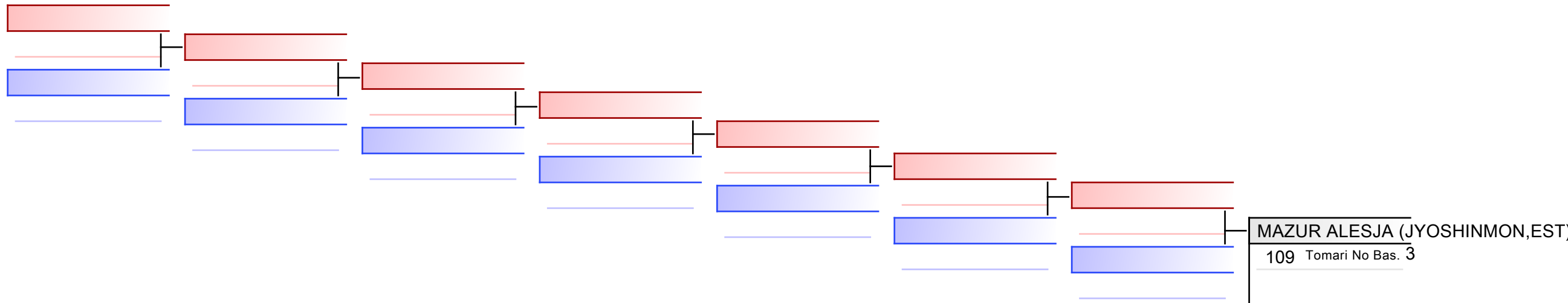

REPECHAGE: (1)

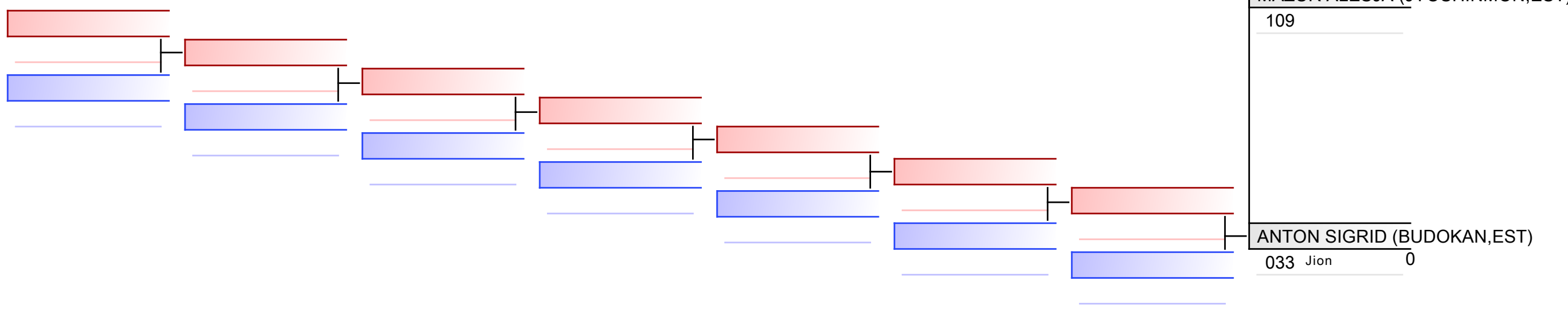

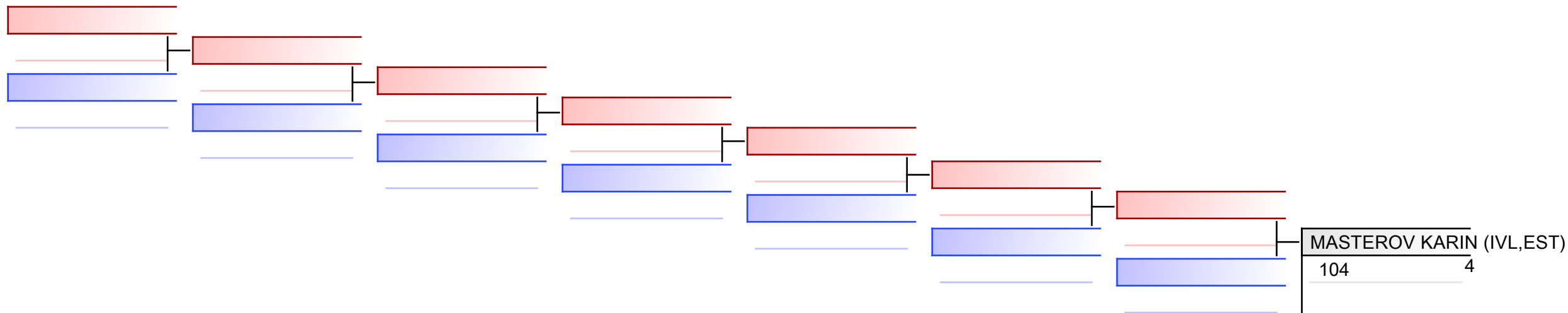

REPECHAGE: (1)

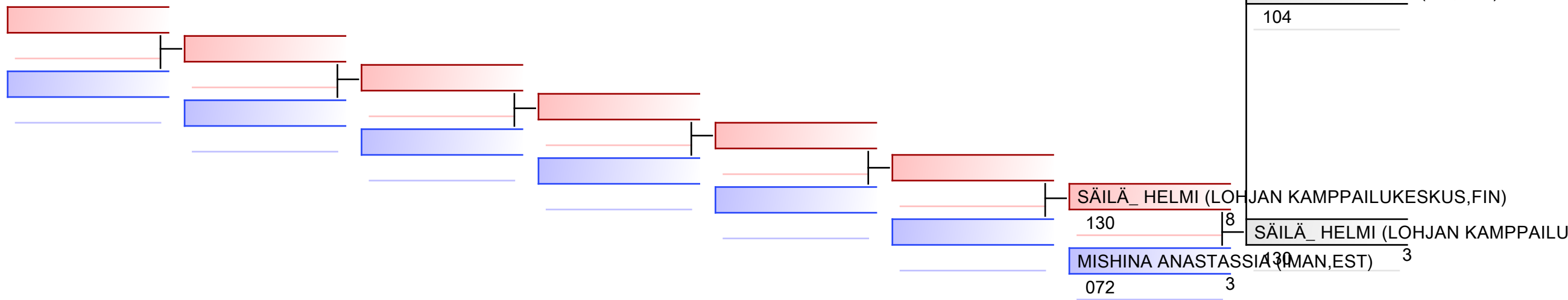

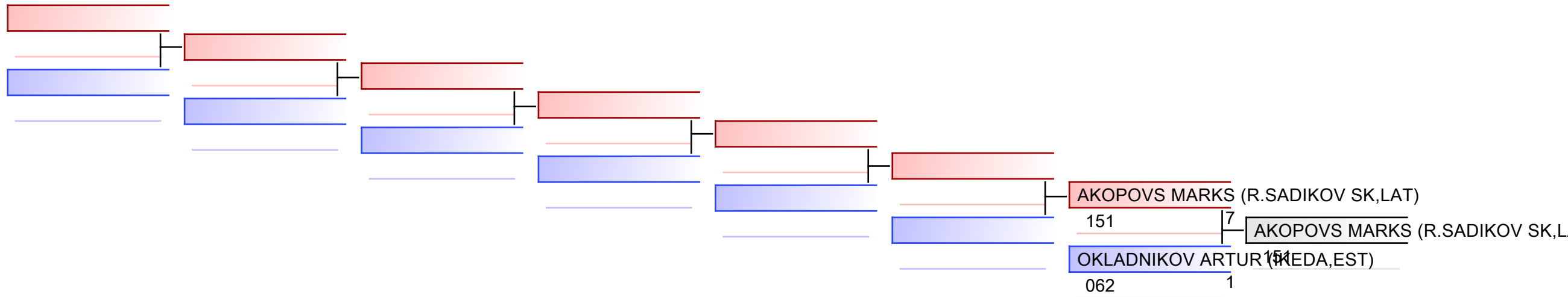

REPECHAGE: (1)

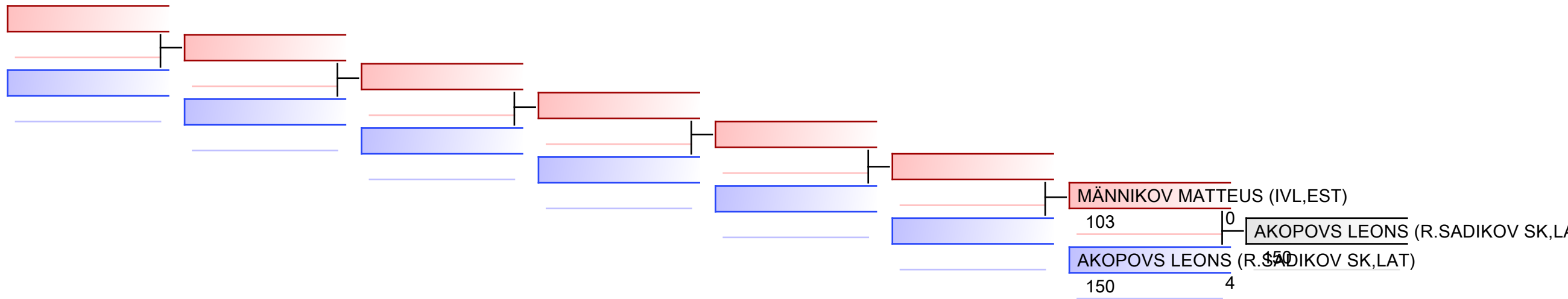



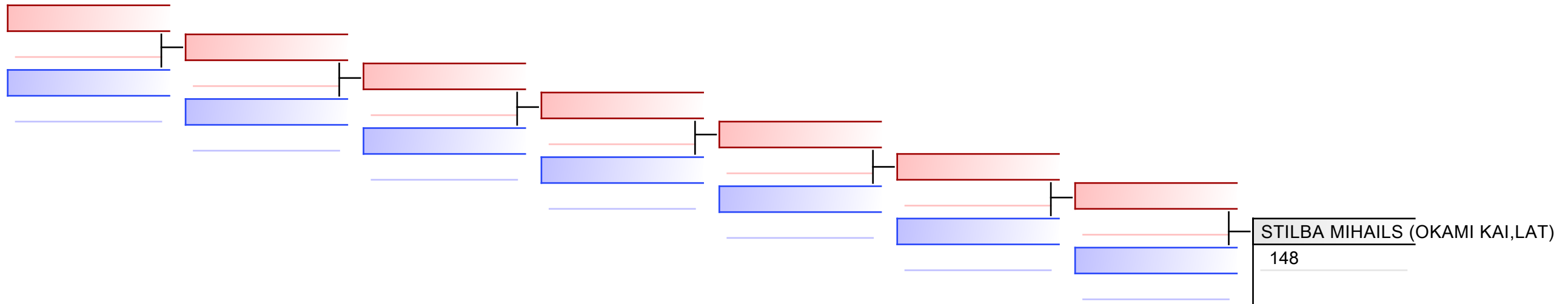

REPECHAGE: (1)

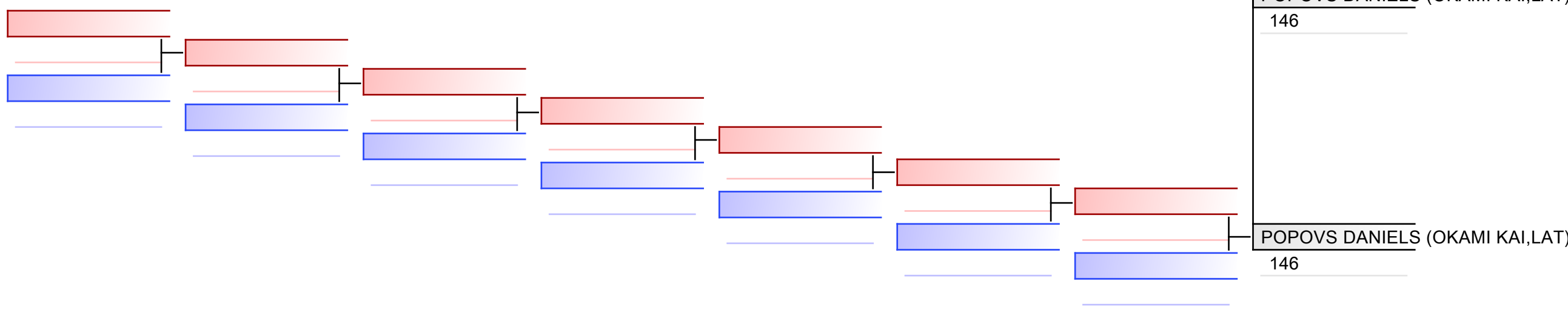

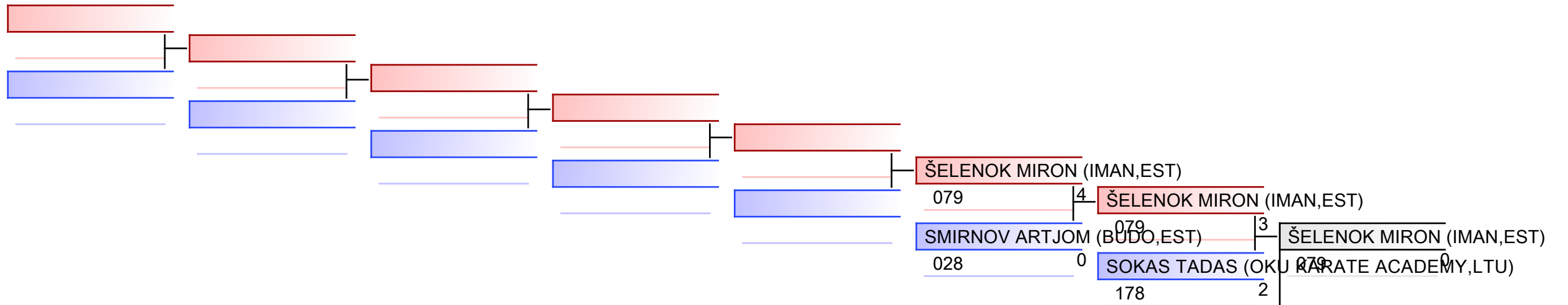

REPECHAGE: (1)

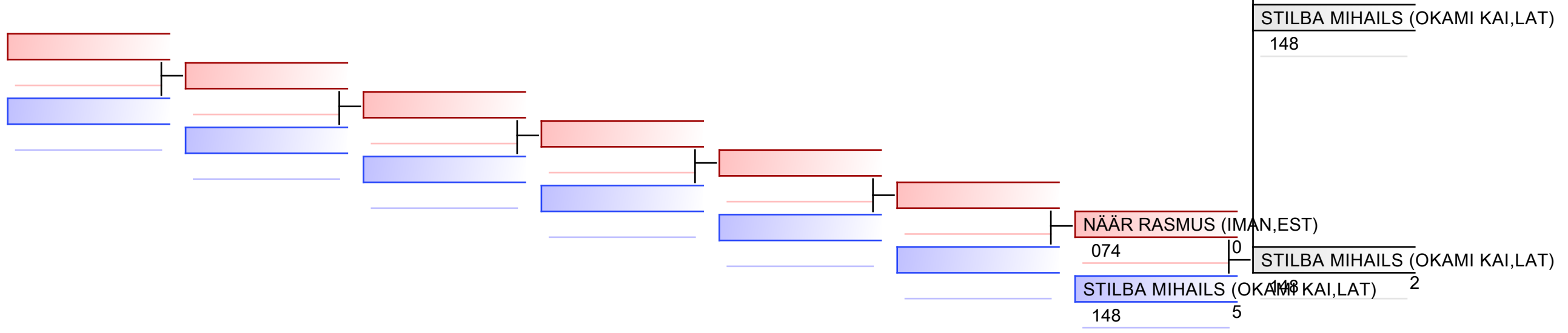

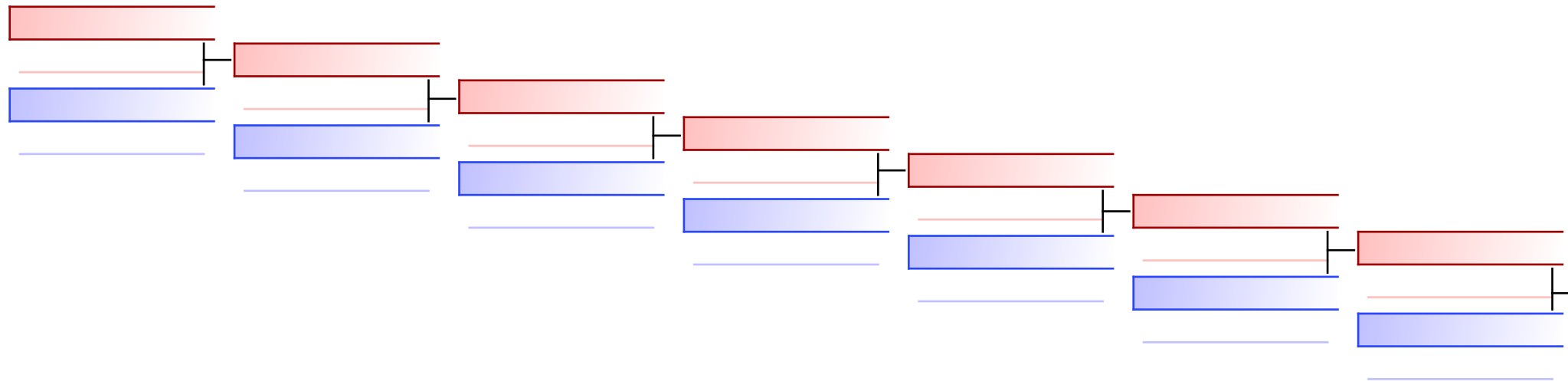

KLEPININ SILANTI-GERHARD (BUDO)  
019 2

REPECHAGE: (1)

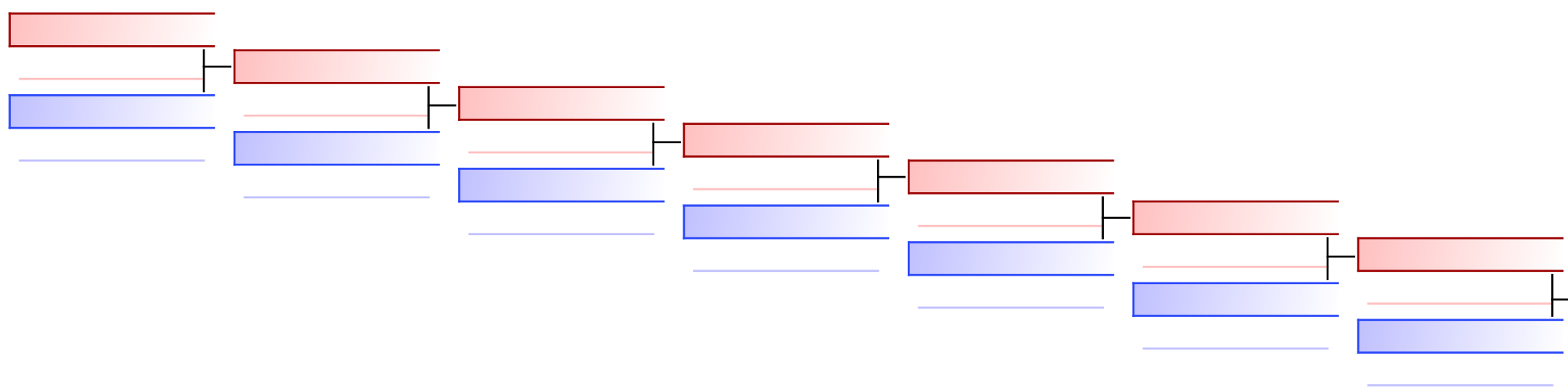

NESTERENKO\_ARTUR (BUDO,EST)  
024

NESTERENKO\_ARTUR (BUDO,EST)  
024 3

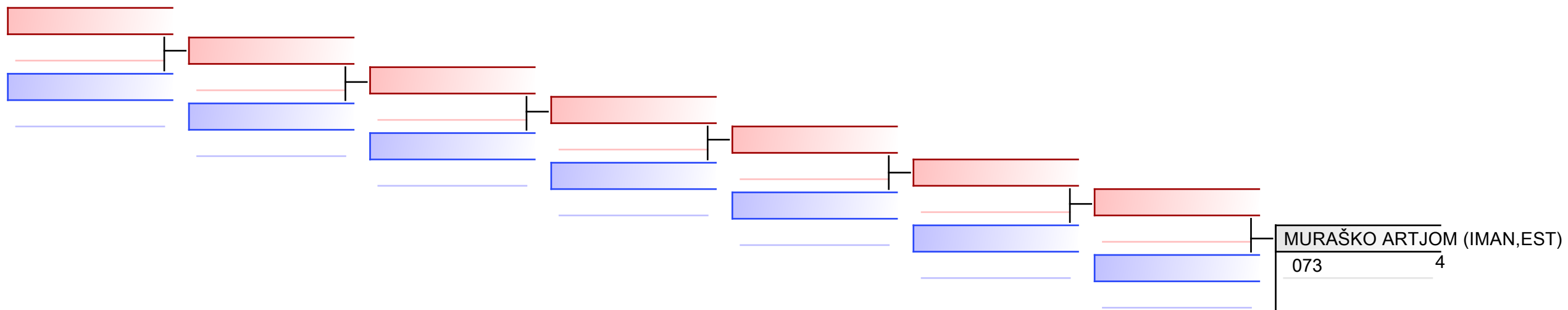

REPECHAGE: (1)

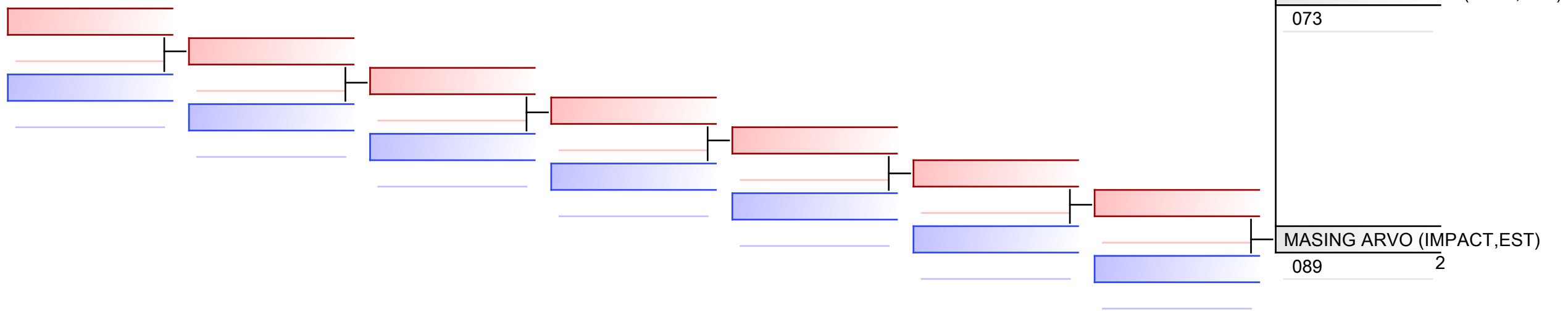

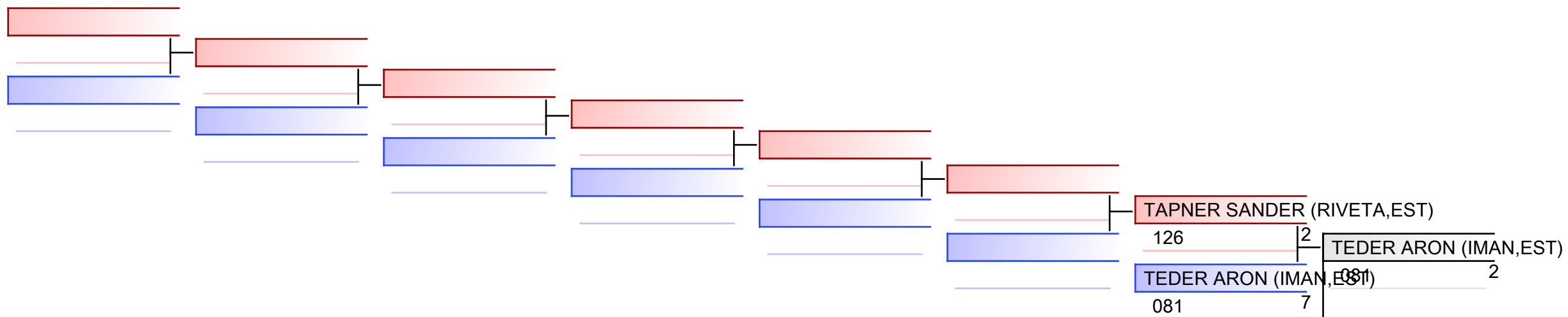

REPECHAGE: (1)

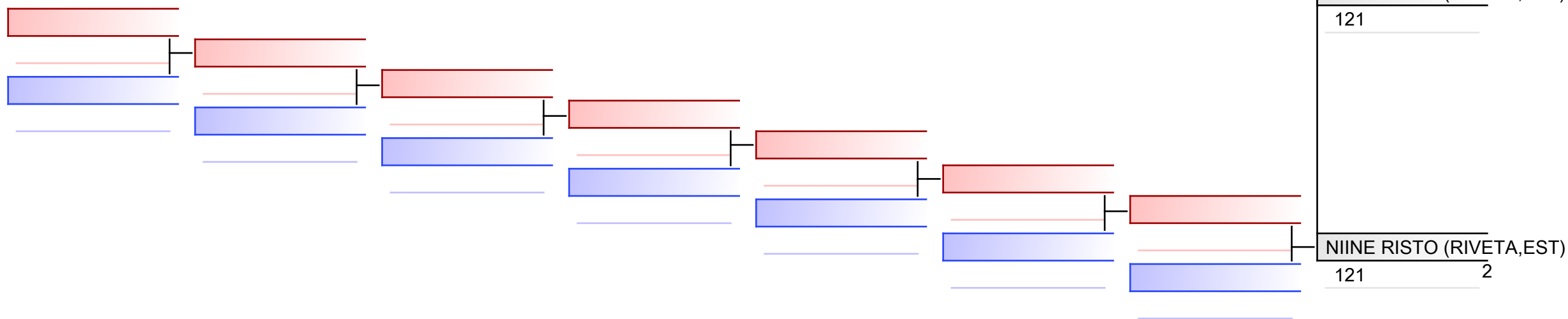

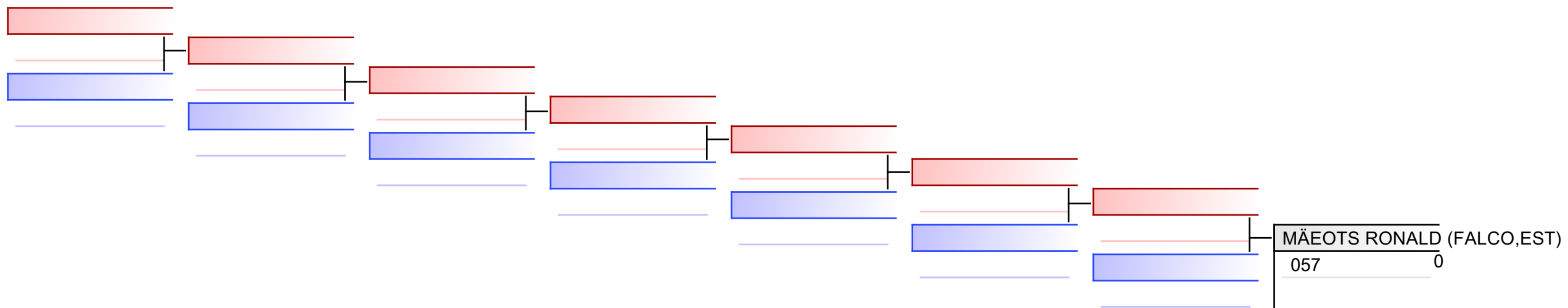

REPECHAGE: (1)

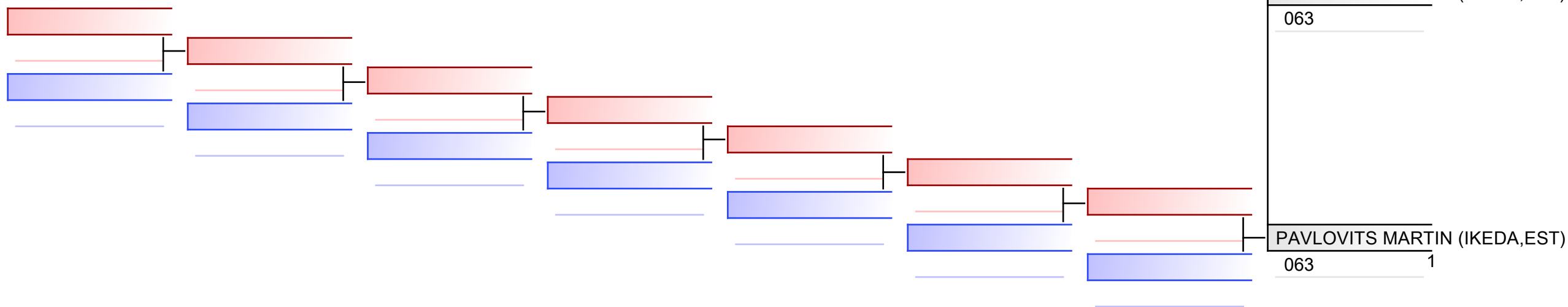

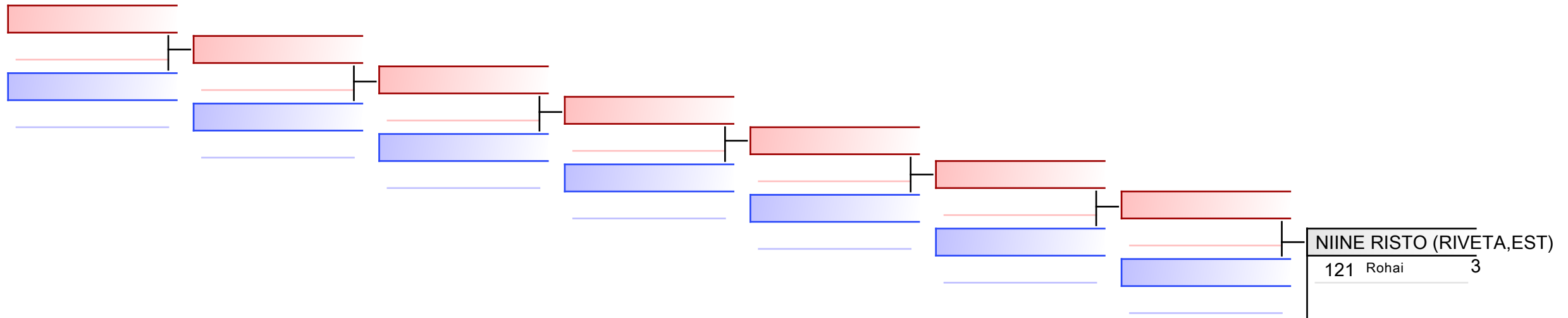

REPECHAGE: (1)

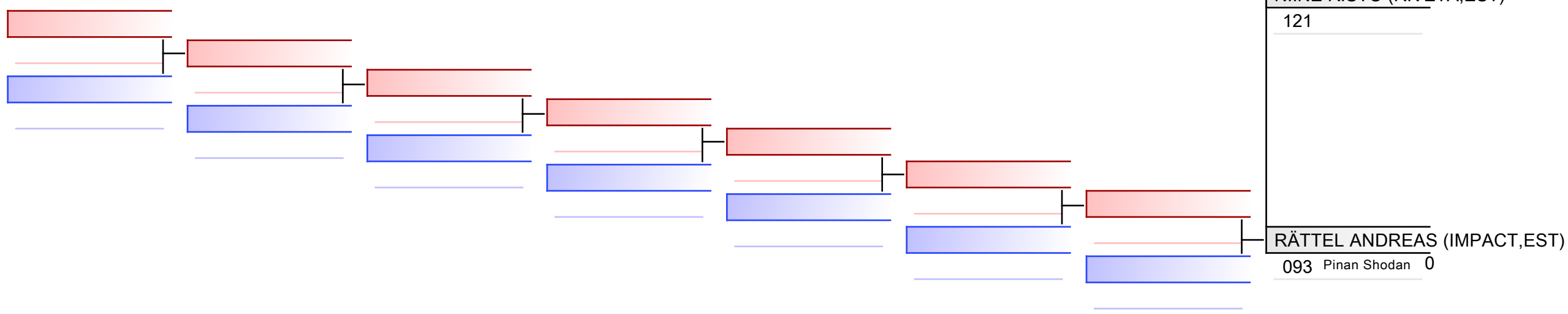

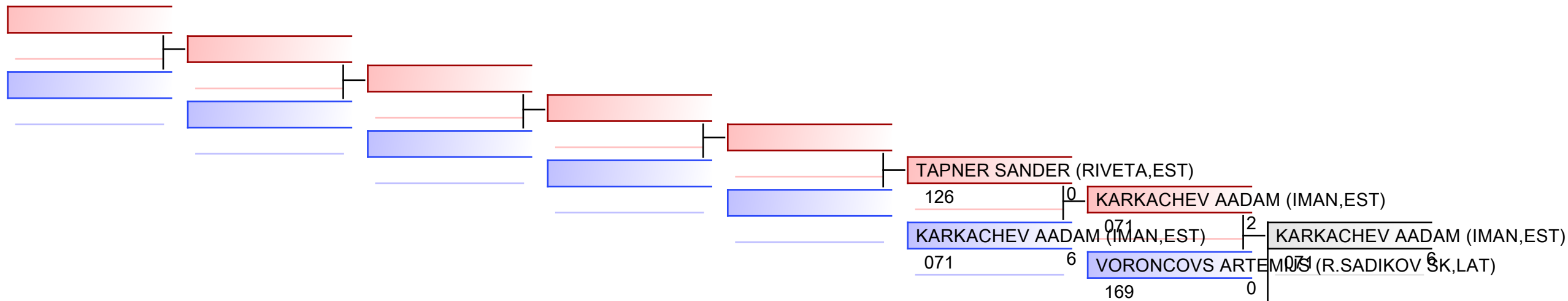

REPECHAGE: (1)

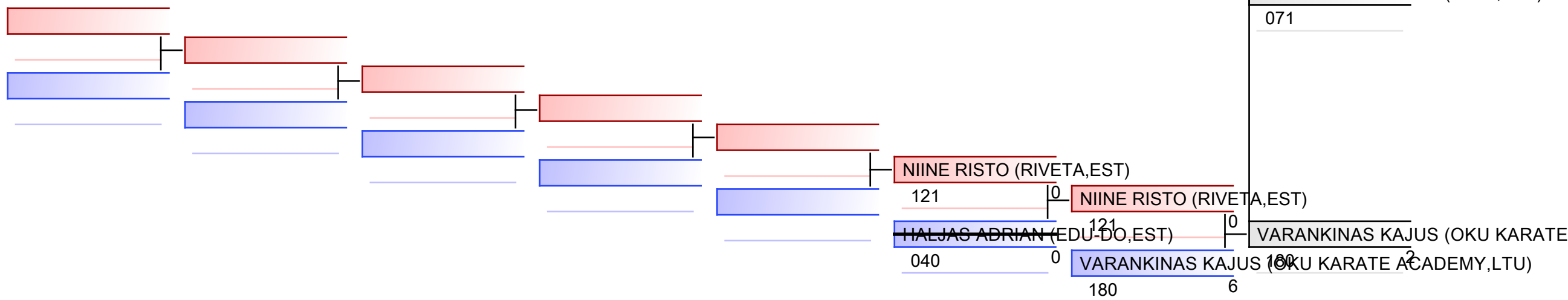



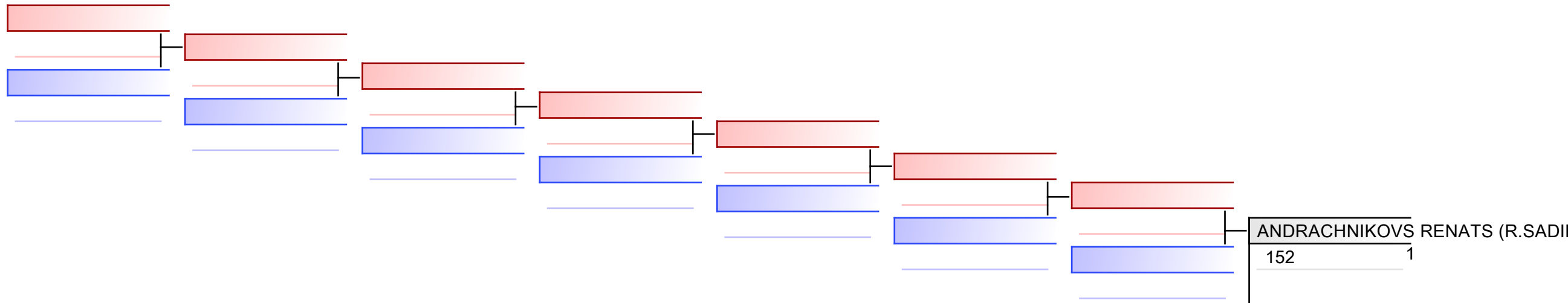

REPECHAGE: (1)

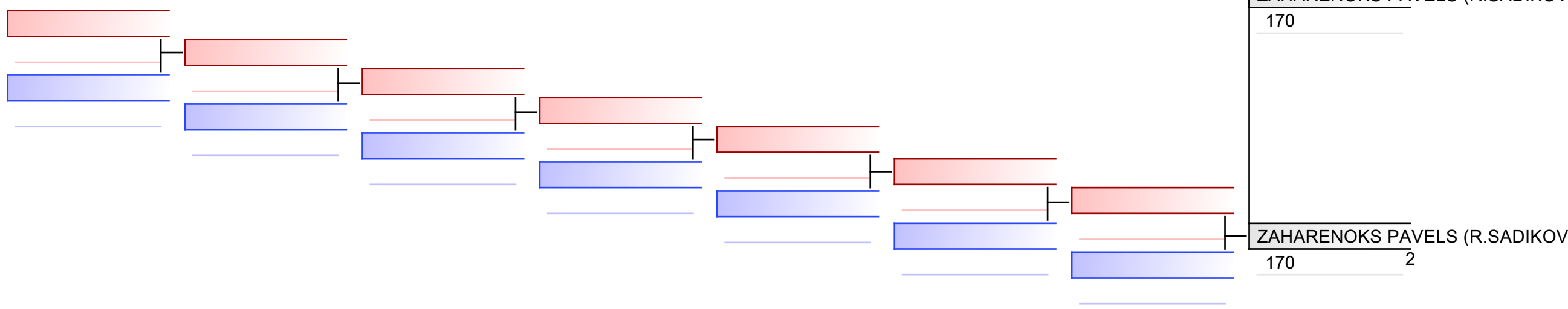

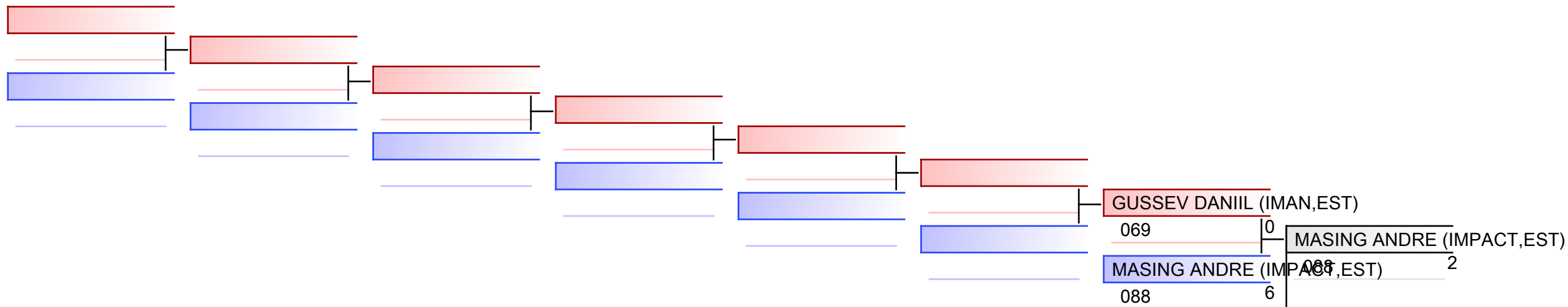

REPECHAGE: (1)

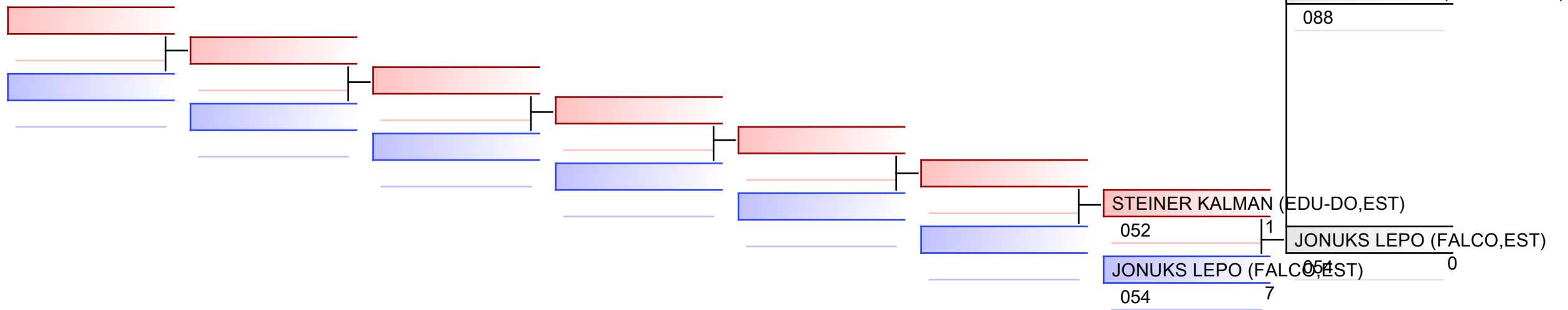

**M U14 -45 kg**

Budo Cup 2021

Tatami  
3 11:25

Pool  
1

(c)sportdata GmbH & Co KG 2000-2021(2021-10-23 18:31) -WKF Approved- v 9.8.7 build 3 (2020-09-25) License: Estonian Karate Federation (expire 2022-11-29)

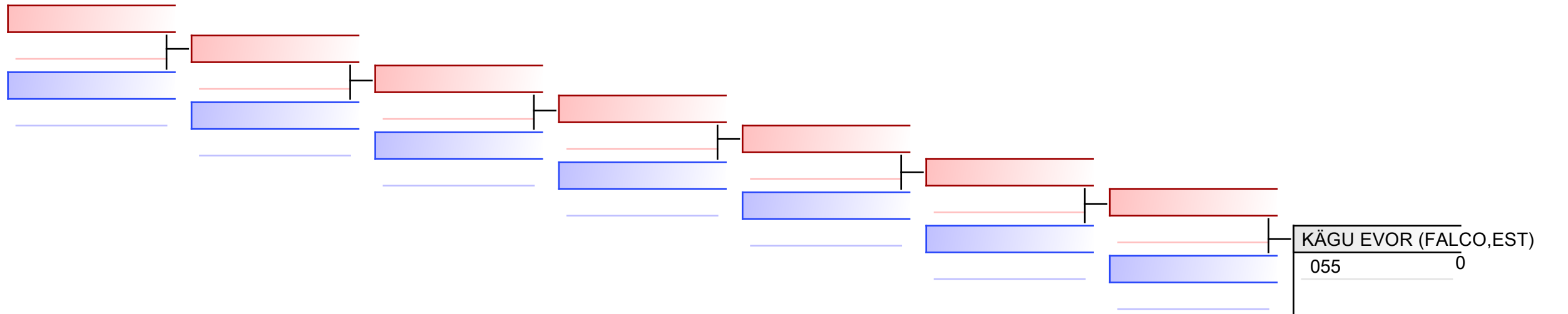

REPECHAGE: (1)

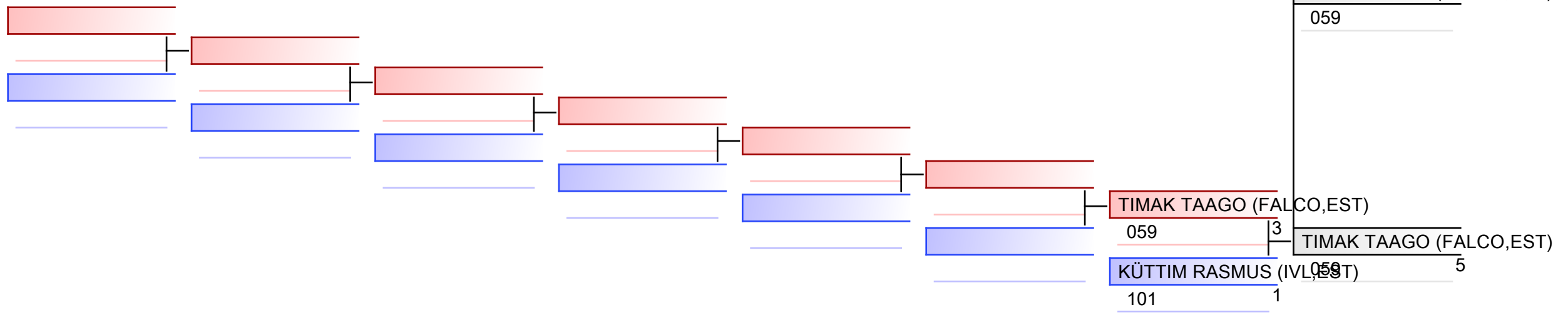

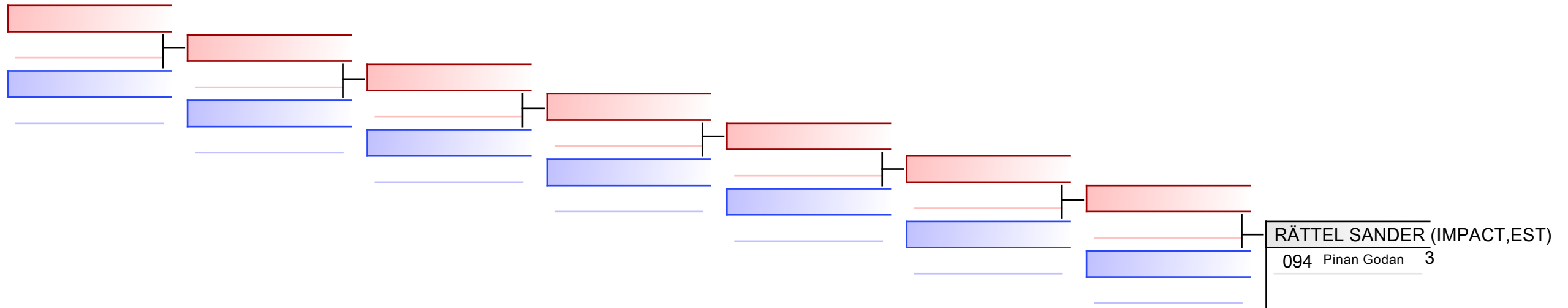

REPECHAGE: (1)

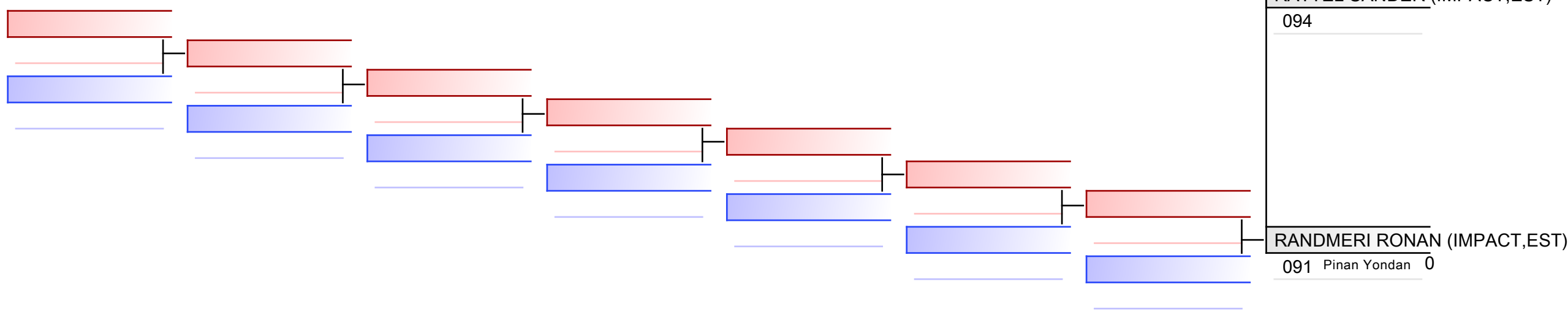

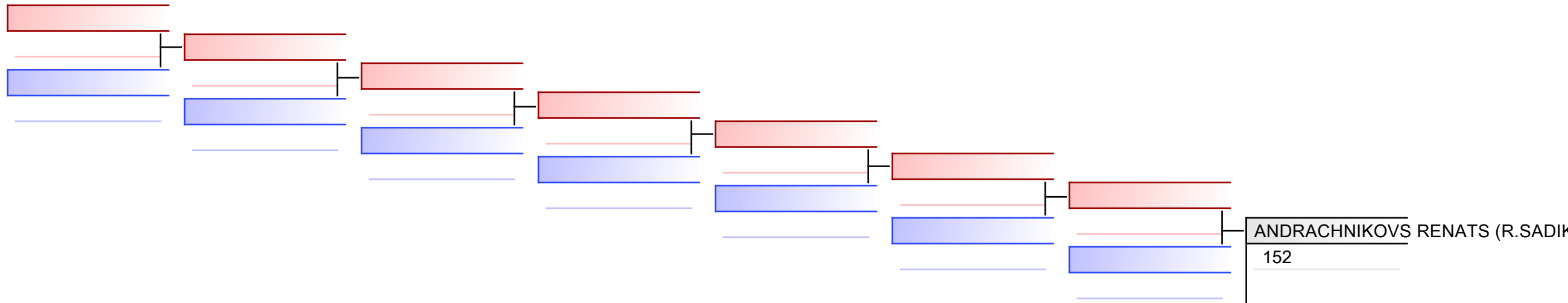

REPECHAGE: (1)

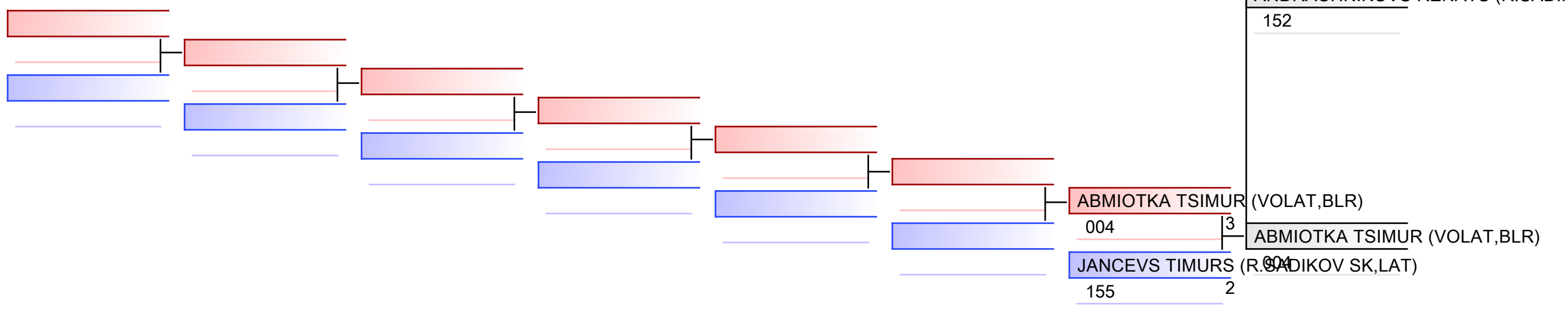

ANDRACHNIKOV'S RENATS (R.SADIKOV SK, LAT)

152

ANDRACHNIKOV'S RENATS (R.SADIKOV SK, LAT)

152

ABMIOTKA TSIMUR (VOLAT, BLR)

004

3

ABMIOTKA TSIMUR (VOLAT, BLR)

JANCEVS TIMURS (R.SADIKOV SK, LAT)

155

2

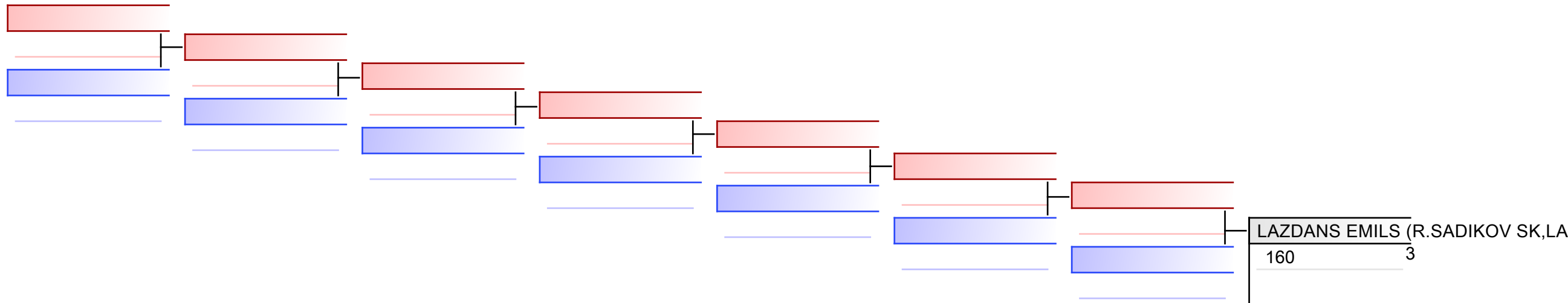

REPECHAGE: (1)

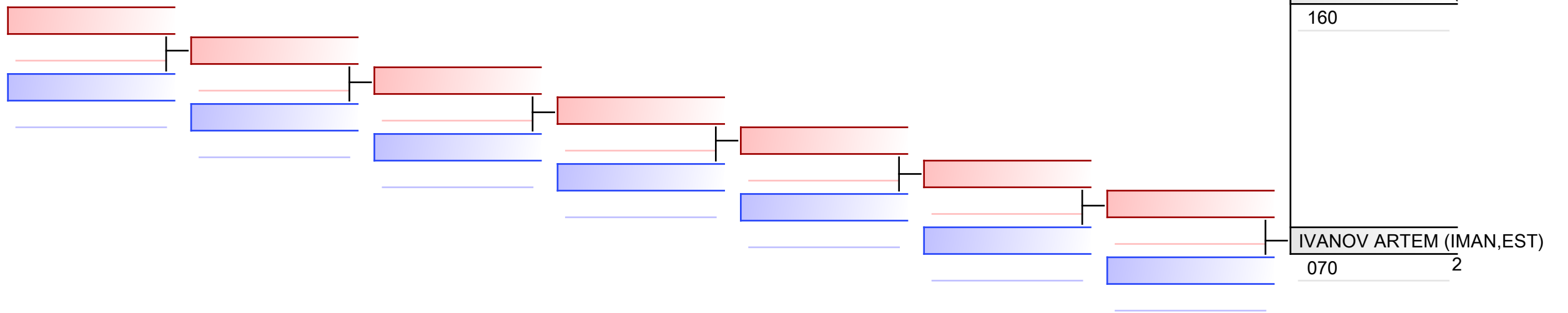

M U16 -57 kg

Budo Cup 2021

Tatami  
1 13:20

Pool  
1

(c)sportdata GmbH & Co KG 2000-2021(2021-10-23 18:31) -WKF Approved- v 9.8.7 build 3 (2020-09-25) License: Estonian Karate Federation (expire 2022-11-29)

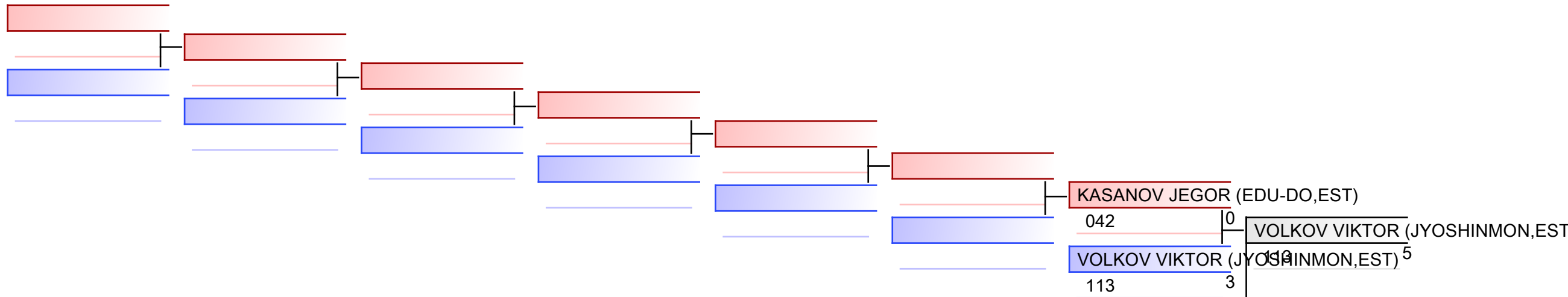

REPECHAGE: (1)

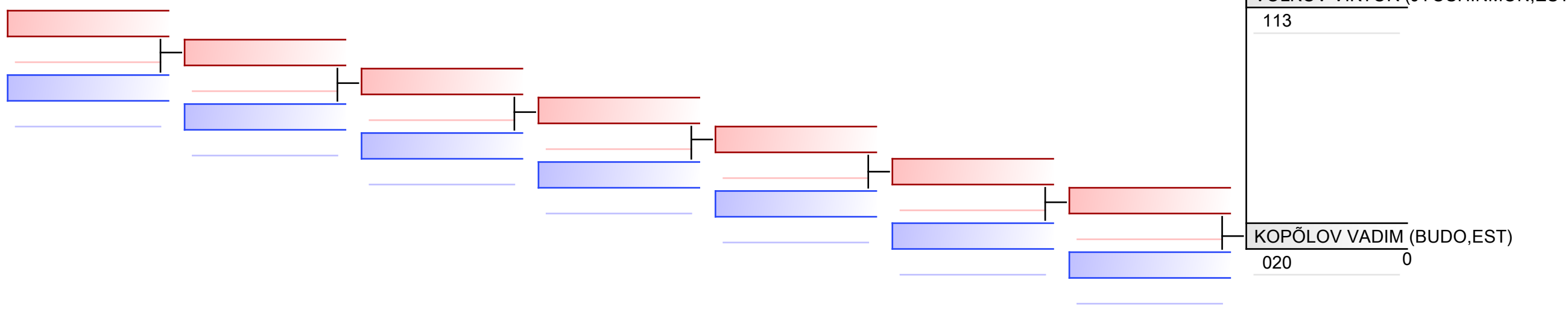

M U16 -70 kg

Budo Cup 2021

Tatami  
2 14:40

Pool  
1

(c)sportdata GmbH & Co KG 2000-2021(2021-10-23 18:31) -WKF Approved- v 9.8.7 build 3 (2020-09-25) License: Estonian Karate Federation (expire 2022-11-29)

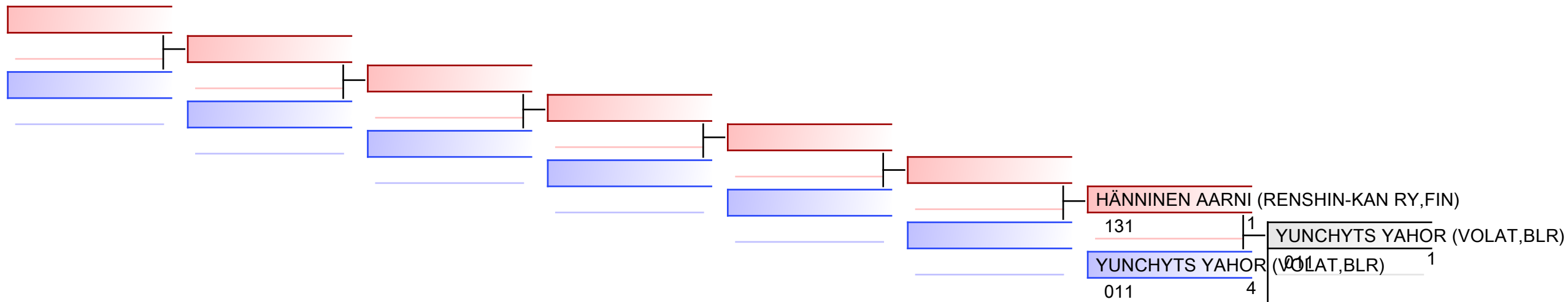

REPECHAGE: (1)

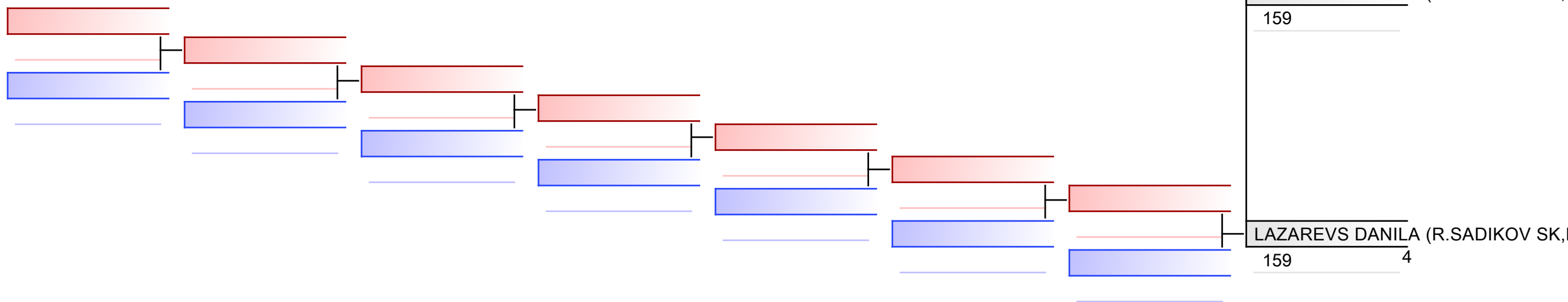



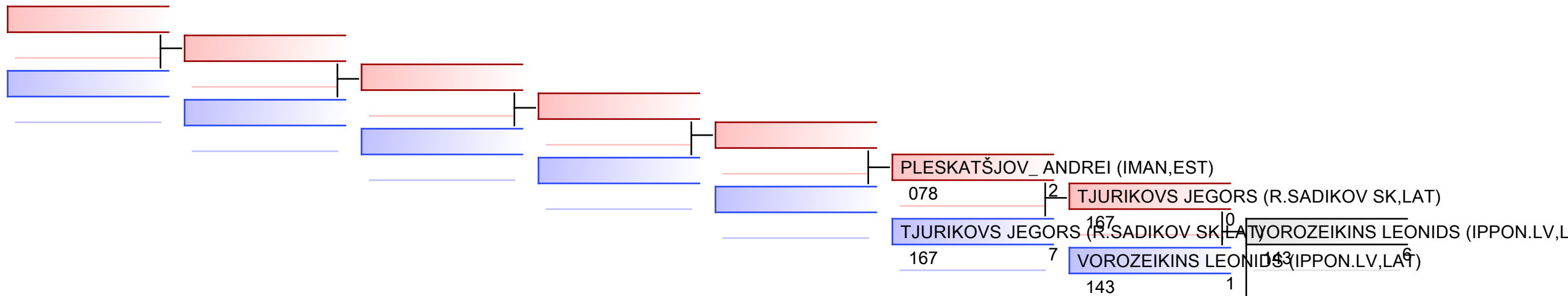

REPECHAGE: (1)

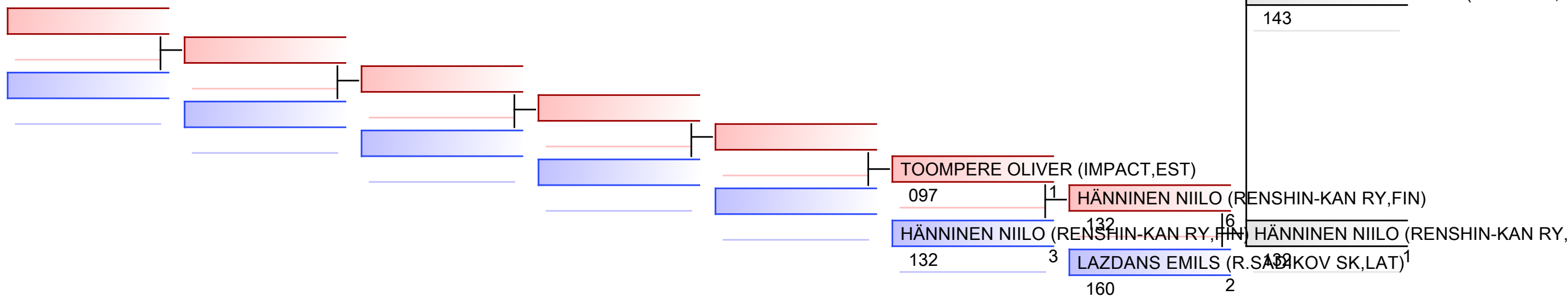

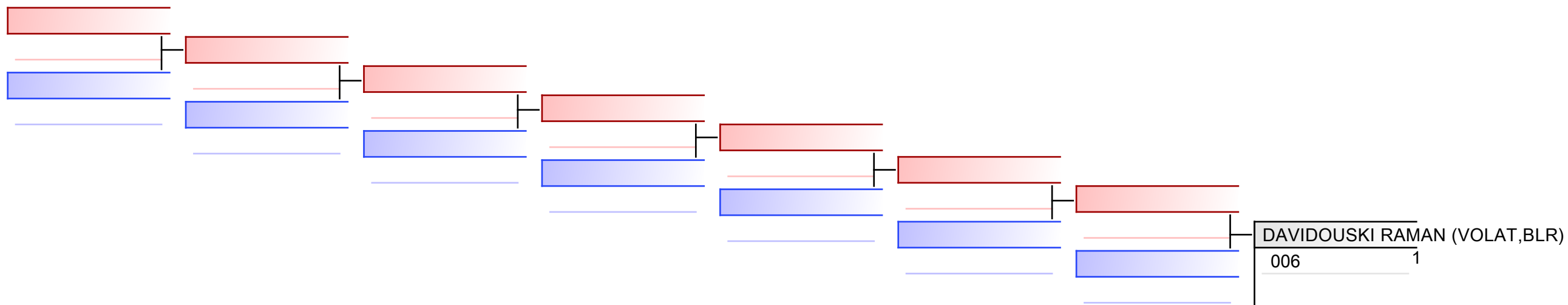

REPECHAGE: (1)

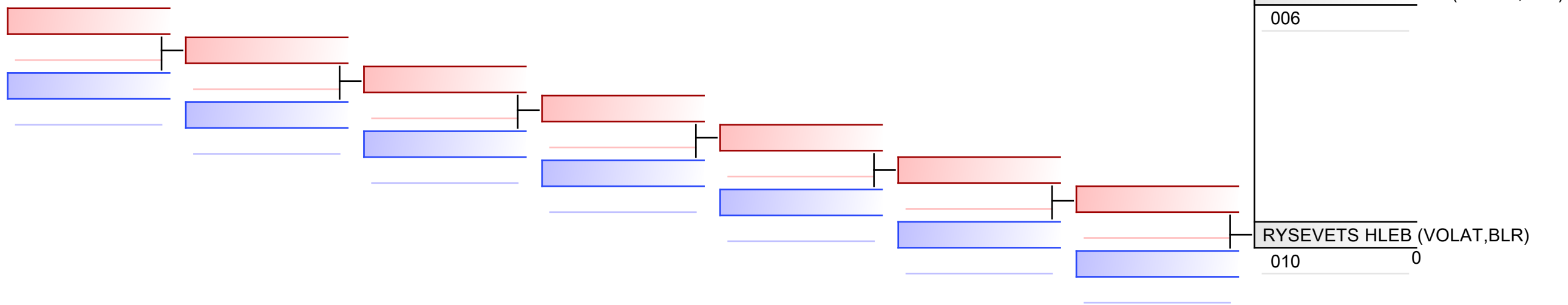

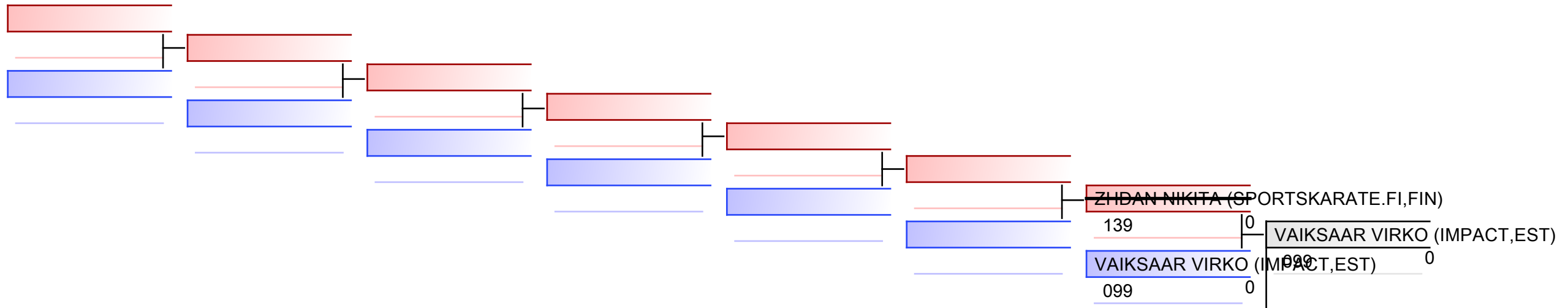

REPECHAGE: (1)

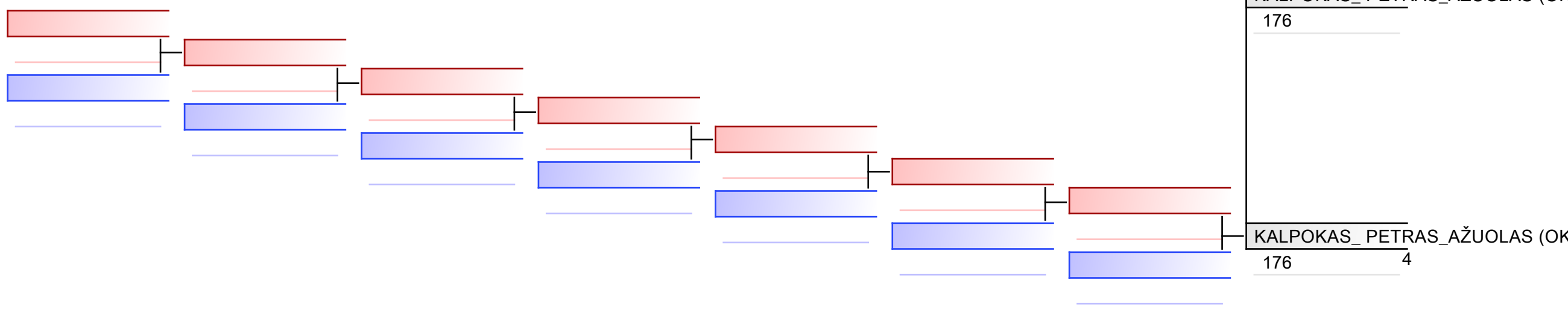

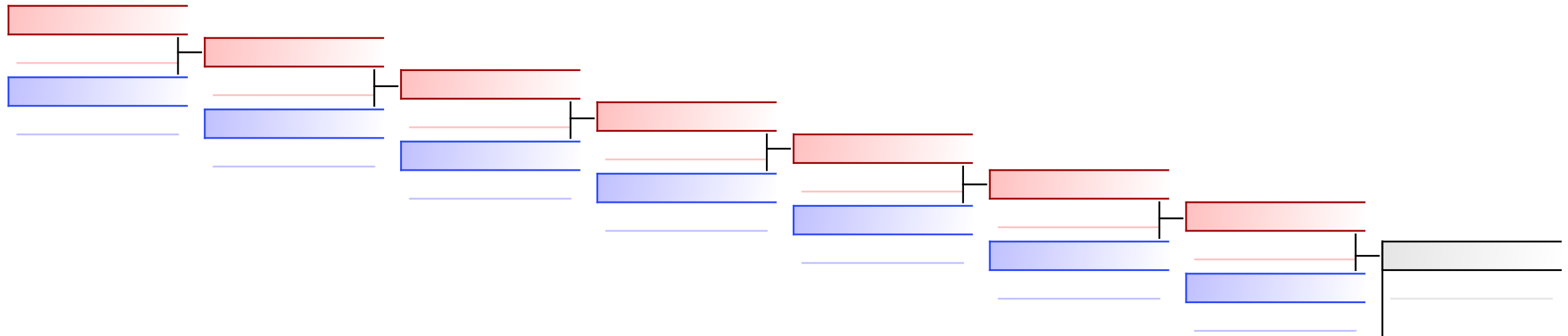

REPECHAGE: (1)

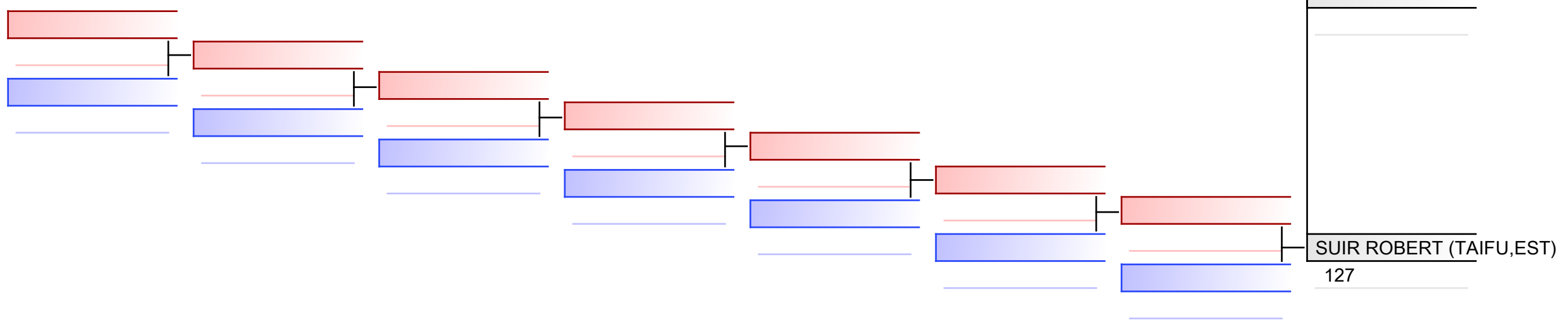

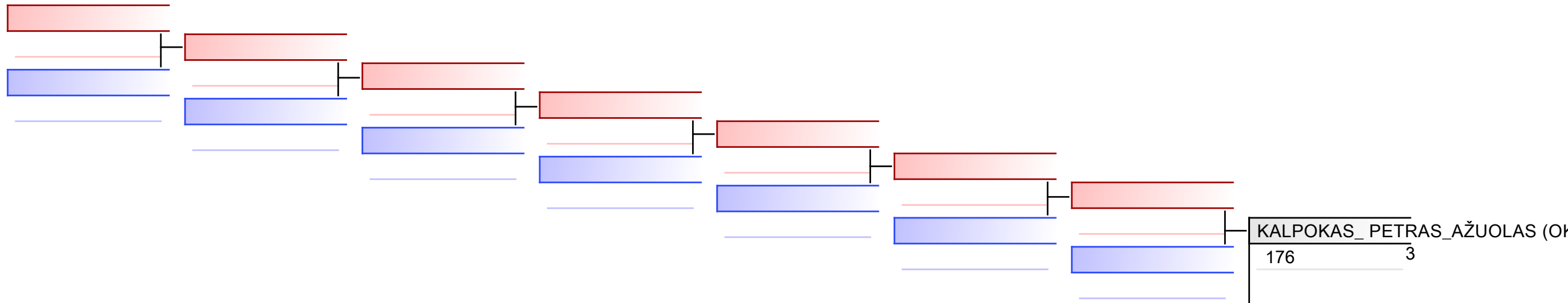

REPECHAGE: (1)

