

F U12 kata

Corpore cup 2021

Tatami
1 11:10

Pool
1

(c)sportdata GmbH & Co KG 2000-2021(2021-09-25 16:36) -WKF Approved- v 9.8.7 build 3 (2020-09-25) License: Estonian Karate Federation (expire 2022-11-29)

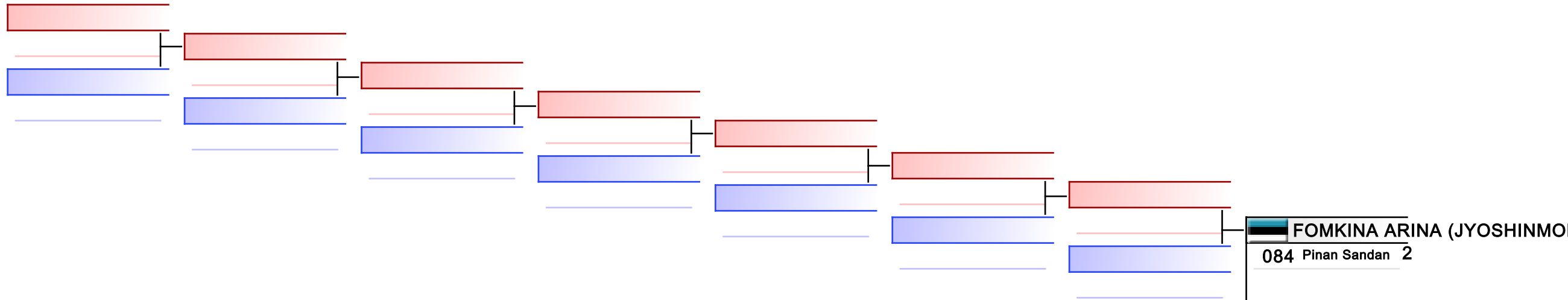

REPECHAGE: (1)

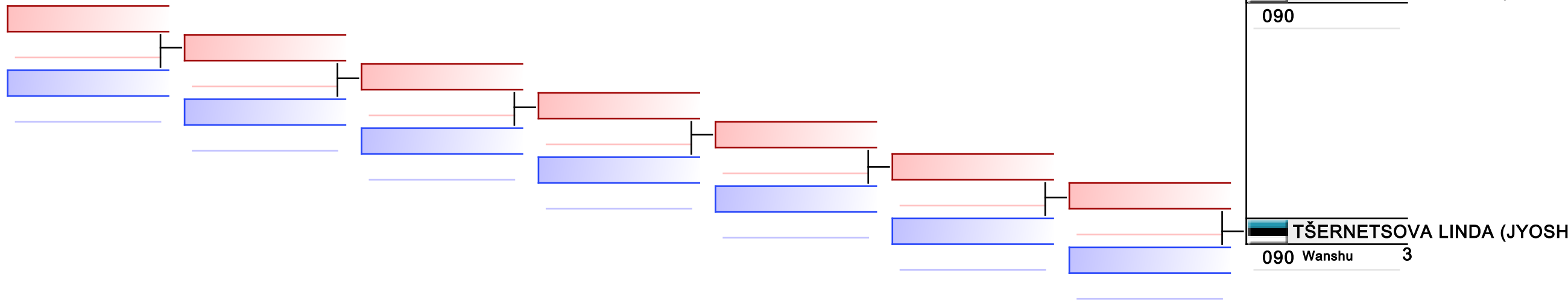

F U14 +47 kg

Corpore cup 2021

Tatami
2 13:00

Pool
1

(c)sportdata GmbH & Co KG 2000-2021(2021-09-25 16:36) -WKF Approved- v 9.8.7 build 3 (2020-09-25) License: Estonian Karate Federation (expire 2022-11-29)

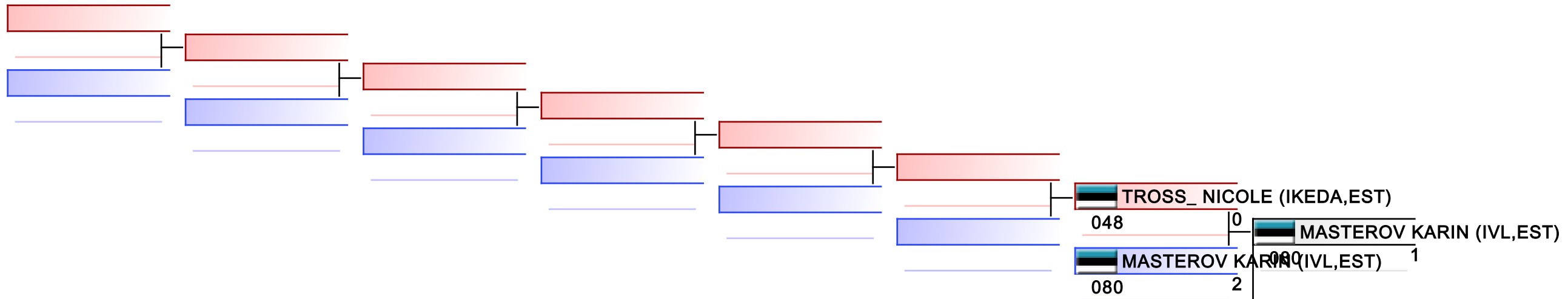

REPECHAGE: (1)

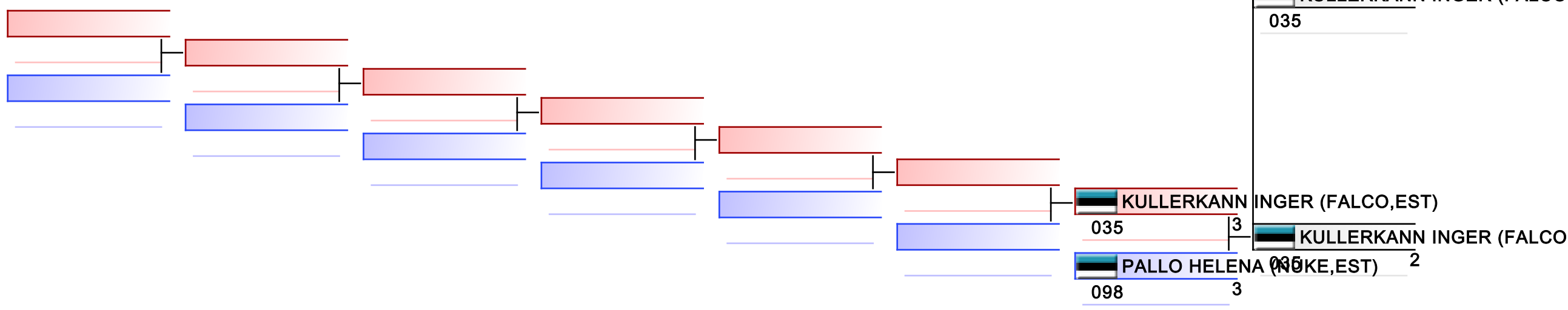

F U14 kata

Corpore cup 2021

Tatami
2 11:25

Pool
1

(c)sportdata GmbH & Co KG 2000-2021(2021-09-25 16:36) -WKF Approved- v 9.8.7 build 3 (2020-09-25) License: Estonian Karate Federation (expire 2022-11-29)

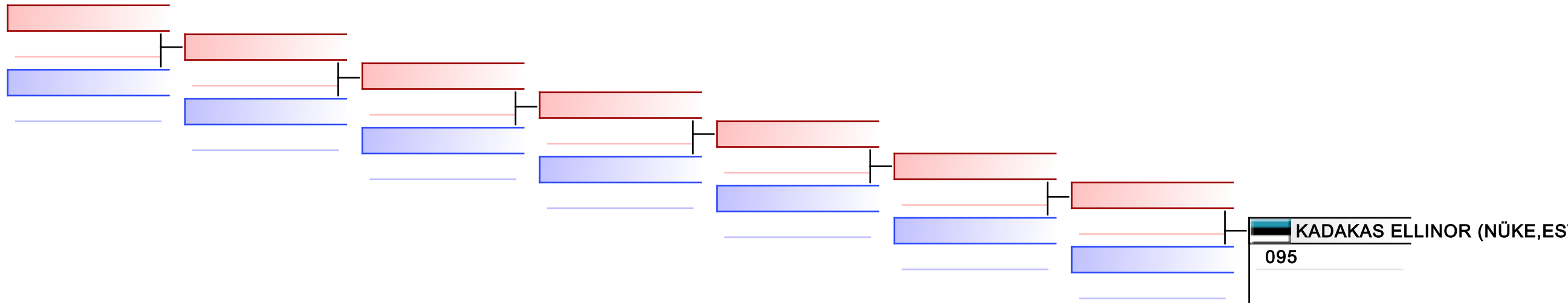

REPECHAGE: (1)

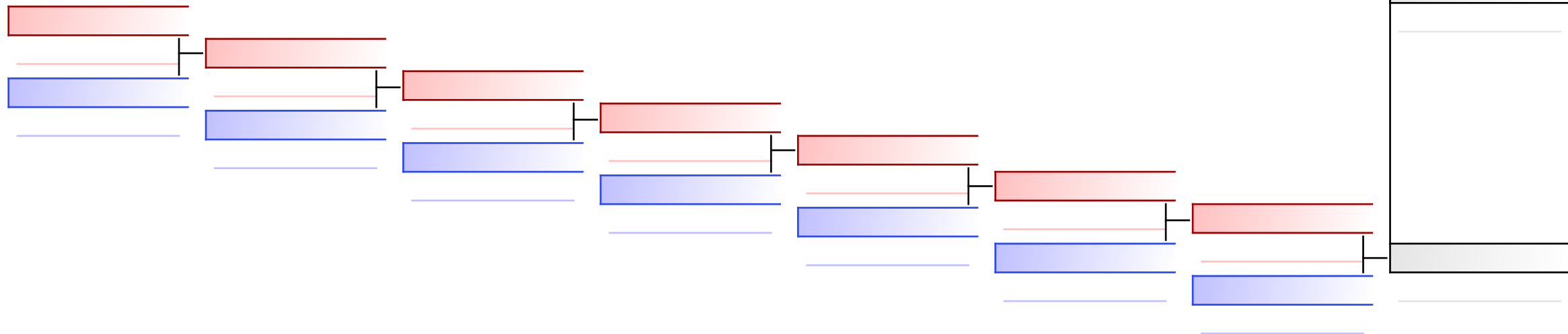

F U16 kata

Corpore cup 2021

(c)sportdata GmbH & Co KG 2000-2021(2021-09-25 16:36) -WKF Approved- v 9.8.7 build 3 (2020-09-25) License: Estonian Karate Federation (expire 2022-11-29)

Tatami
2 11:40

Pool
1

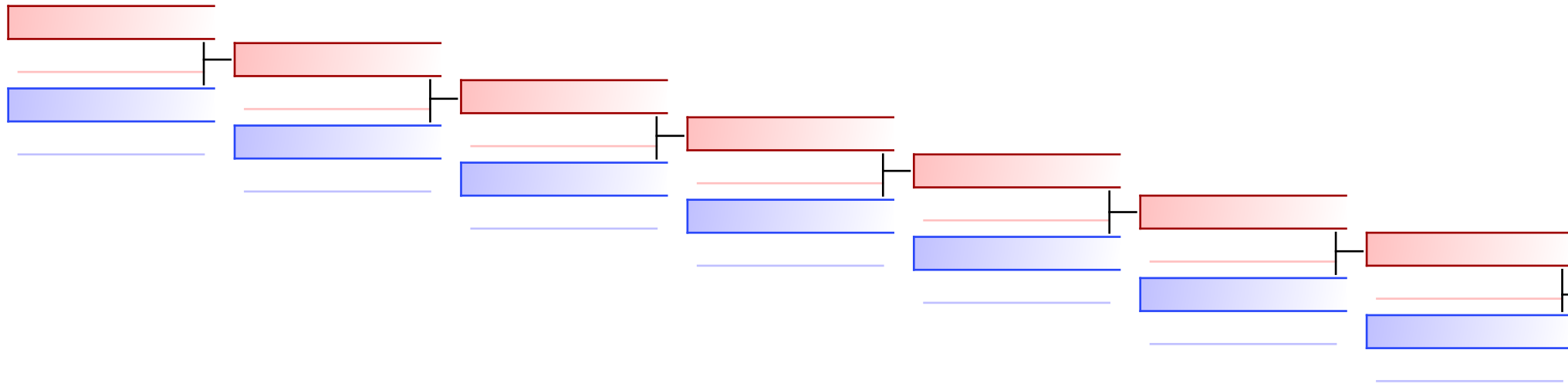

KITT MIA_MIRTEL (NÜKE,EST)
096 Jiin 1

REPECHAGE: (1)

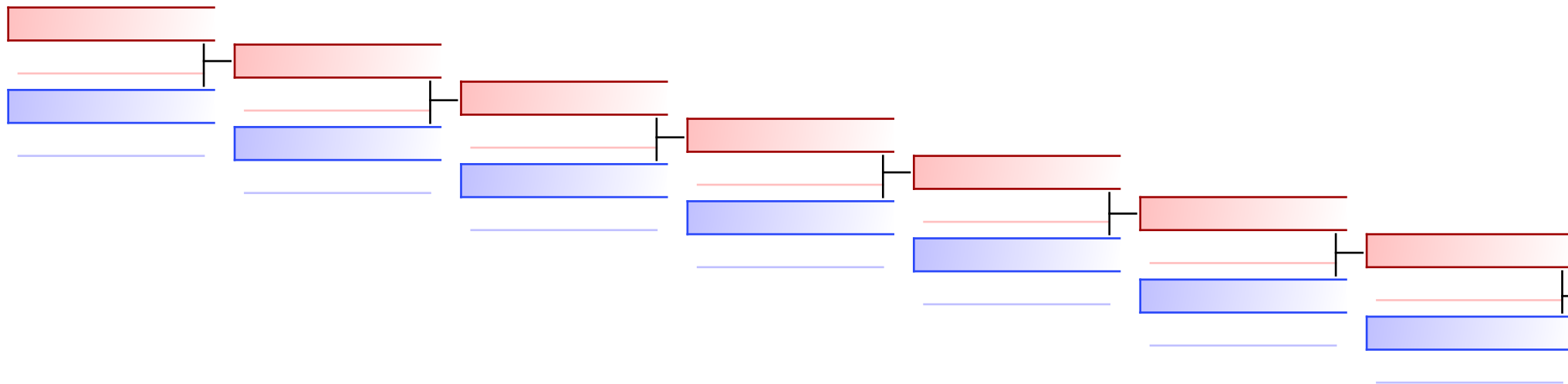

JOSEPSON LOUISE_GRETE (N)
094

JOSEPSON LOUISE_GRETE (N)
094 Jion 4

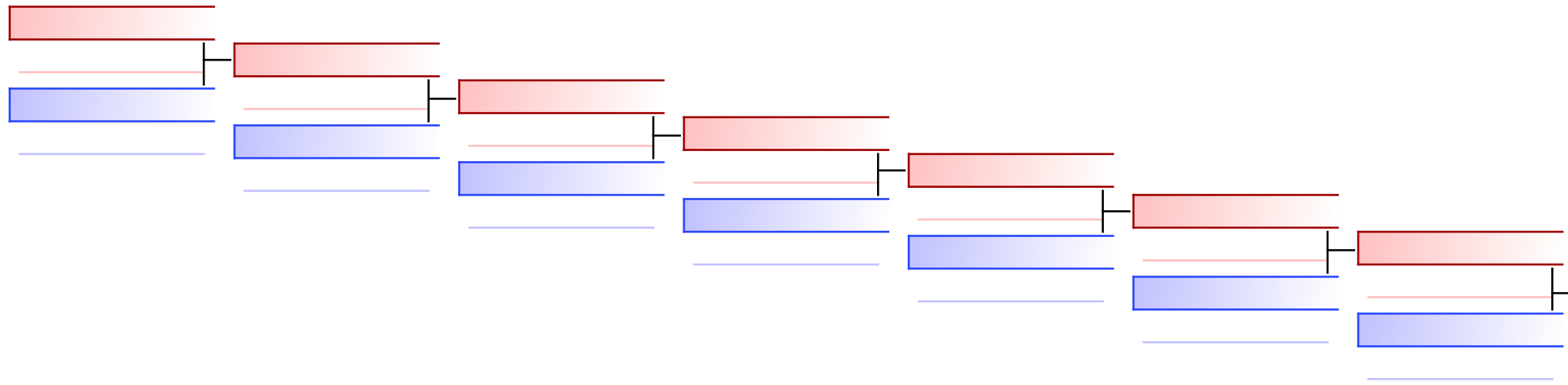

REPECHAGE: (1)

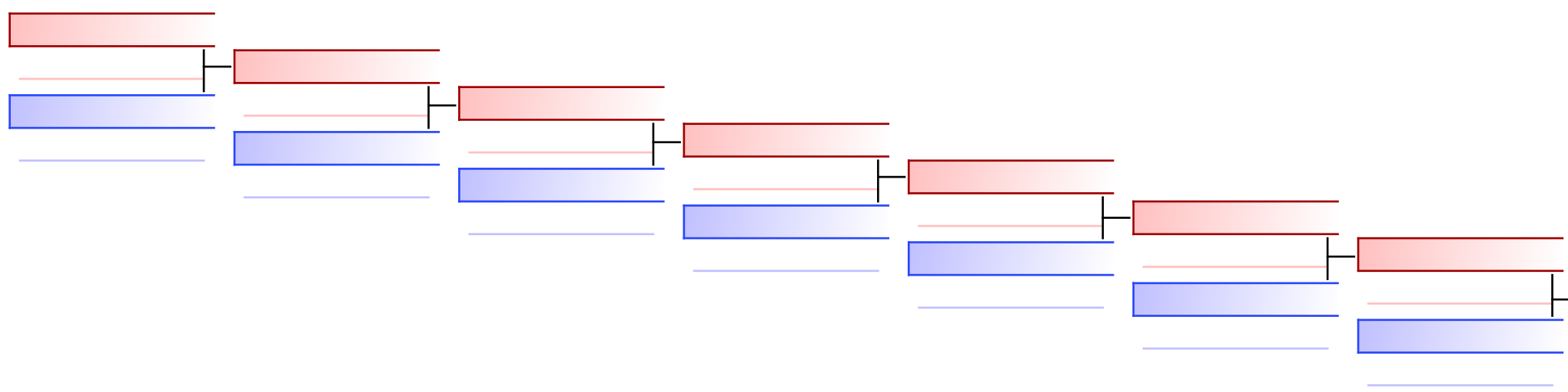

RIABCEVA ANGELINA (EDU-DC)
029 0

LETT ANNALIISA (IMPACT,EST)
067

LETT ANNALIISA (IMPACT,EST)
067 1

M U10 Open
Corpore cup 2021

Tatami
2 12:10

Pool
1

(c)sportdata GmbH & Co KG 2000-2021(2021-09-25 16:36) -WKF Approved- v 9.8.7 build 3 (2020-09-25) License: Estonian Karate Federation (expire 2022-11-29)

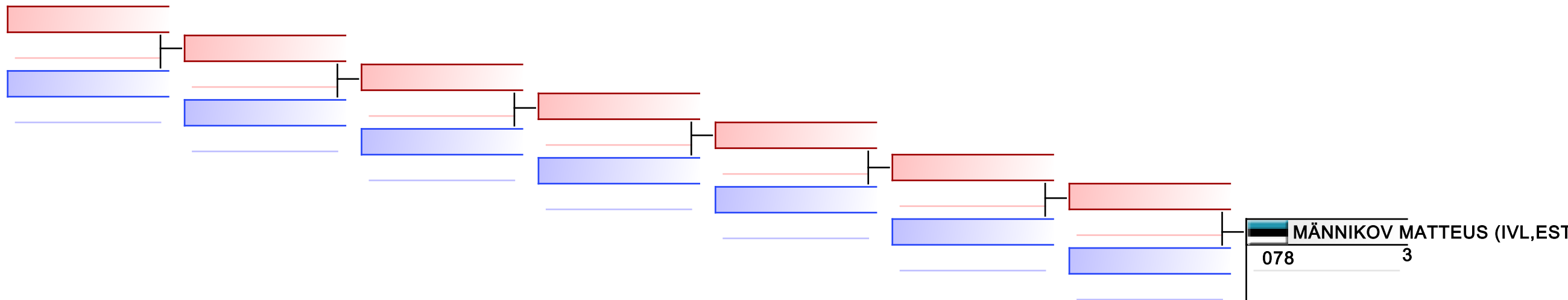

REPECHAGE: (1)

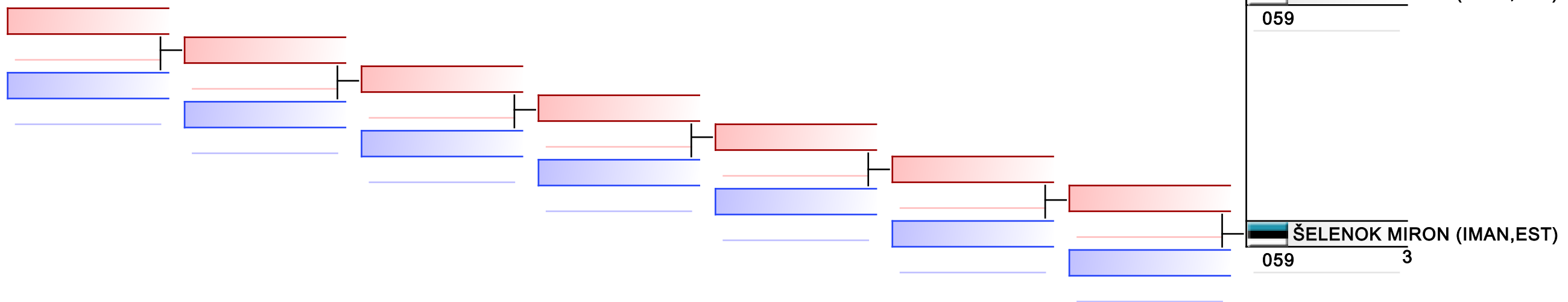

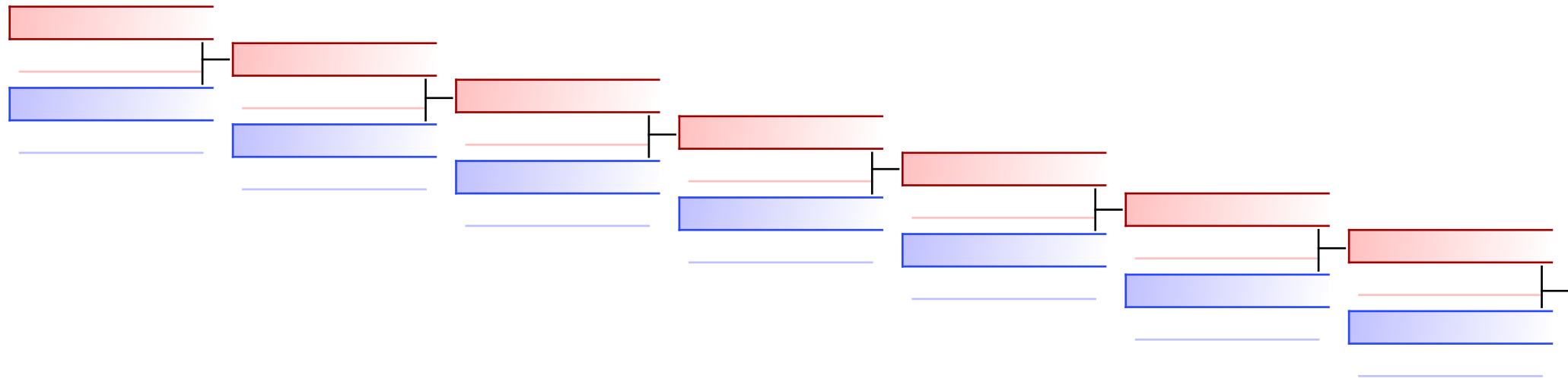

REPECHAGE: (1)

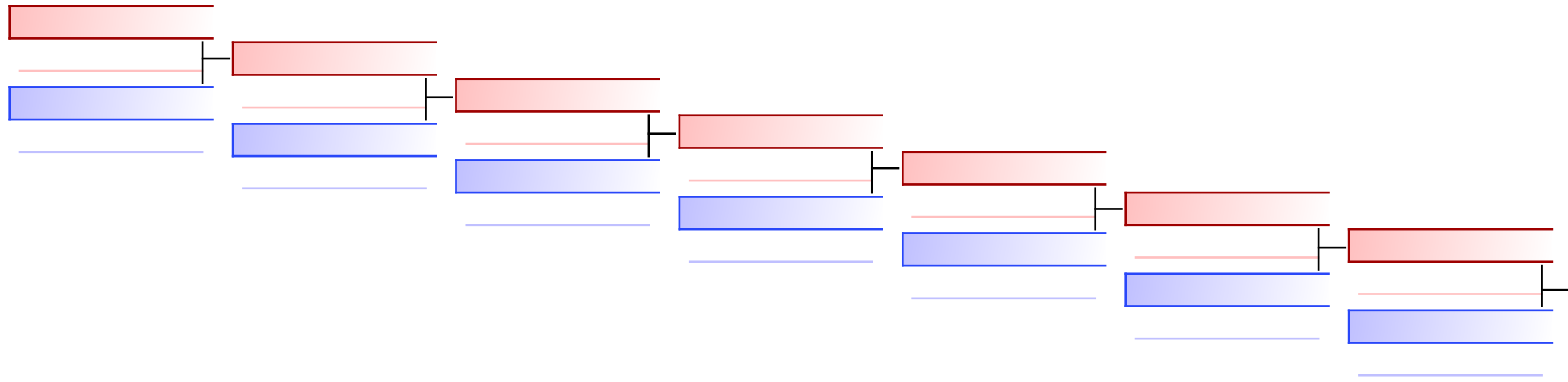

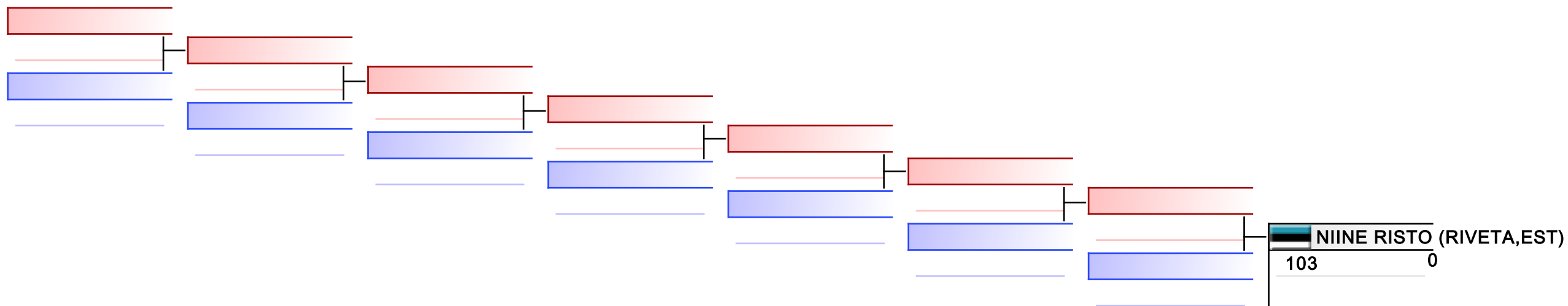

REPECHAGE: (1)

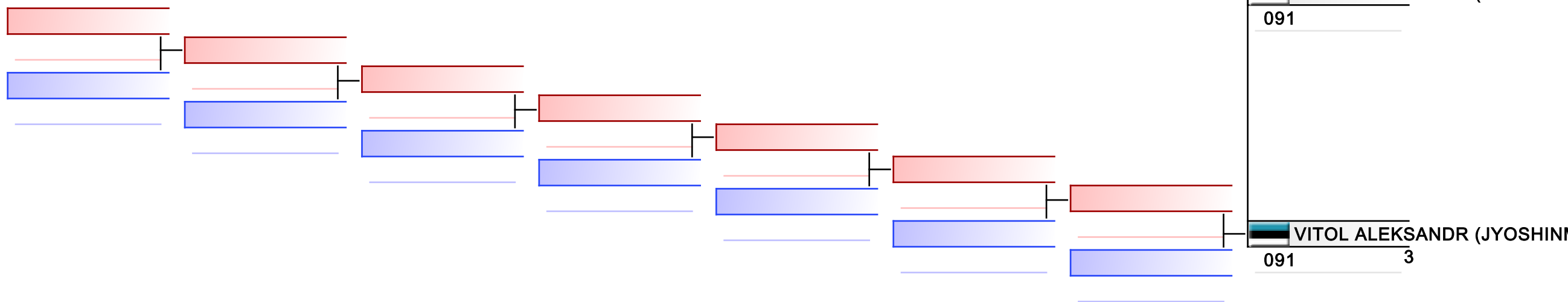

M U14 +55 kg

Corpore cup 2021

Tatami
1 14:10

Pool
1

(c)sportdata GmbH & Co KG 2000-2021(2021-09-25 16:36) -WKF Approved- v 9.8.7 build 3 (2020-09-25) License: Estonian Karate Federation (expire 2022-11-29)

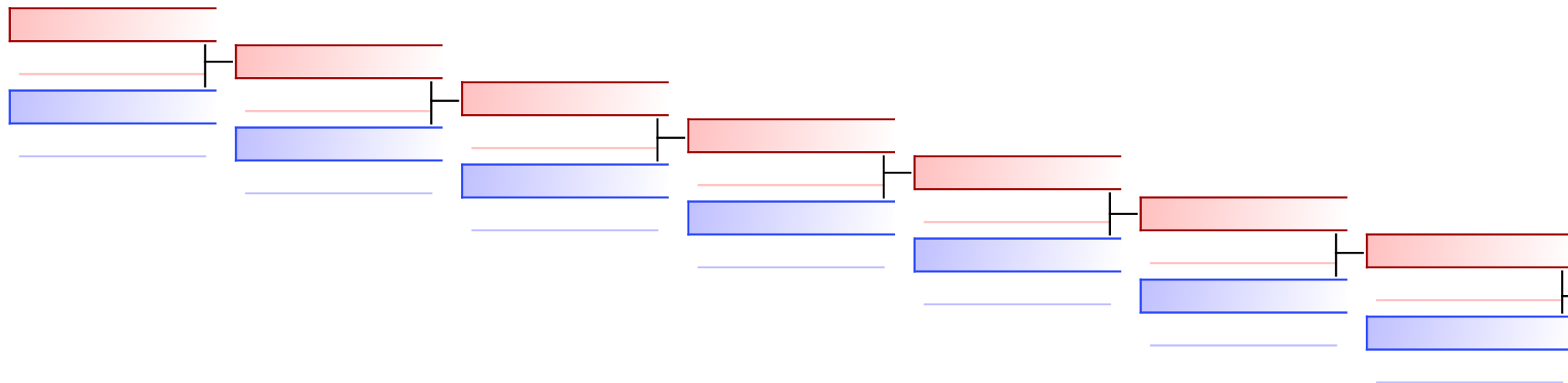

REPECHAGE: (1)

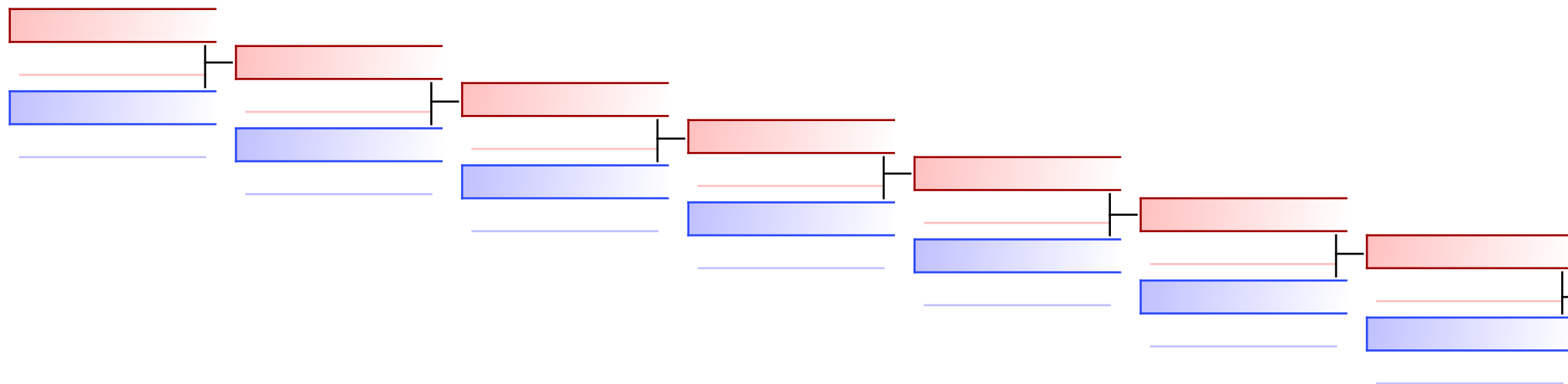

BRÄUTIGAM RICHARD (CORPO)
018 0

BRÄUTIGAM RICHARD (CORPO)
018

ARRO ARO_ARGO (IMPACT, ES)
063 0

M U14 -40 kg

Corpore cup 2021

Tatami
1 13:25

Pool
1

(c)sportdata GmbH & Co KG 2000-2021(2021-09-25 16:36) -WKF Approved- v 9.8.7 build 3 (2020-09-25) License: Estonian Karate Federation (expire 2022-11-29)

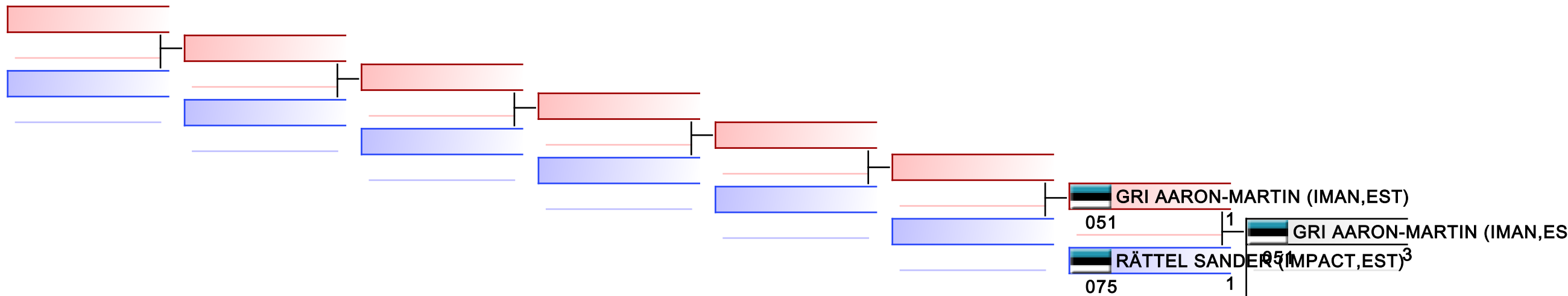

REPECHAGE: (1)

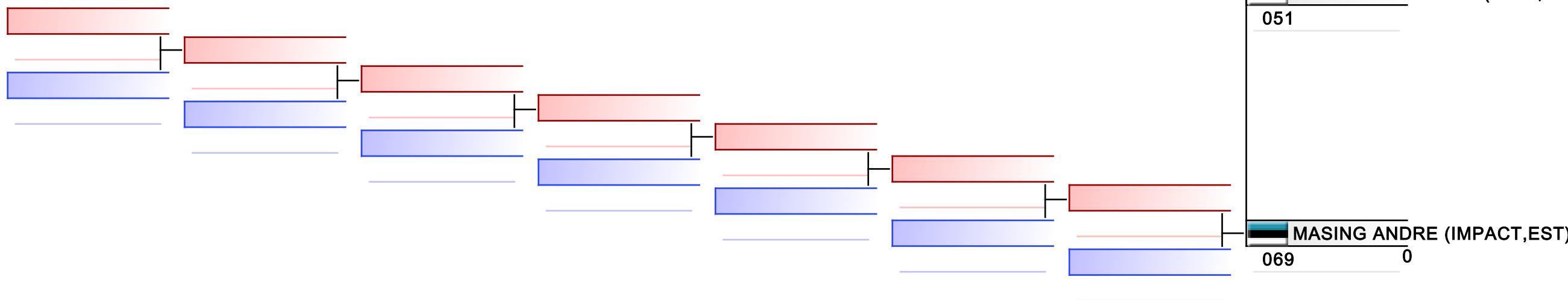

M U14 -45 kg

Corpore cup 2021

Tatami
1 13:55

Pool
1

(c)sportdata GmbH & Co KG 2000-2021(2021-09-25 16:36) -WKF Approved- v 9.8.7 build 3 (2020-09-25) License: Estonian Karate Federation (expire 2022-11-29)

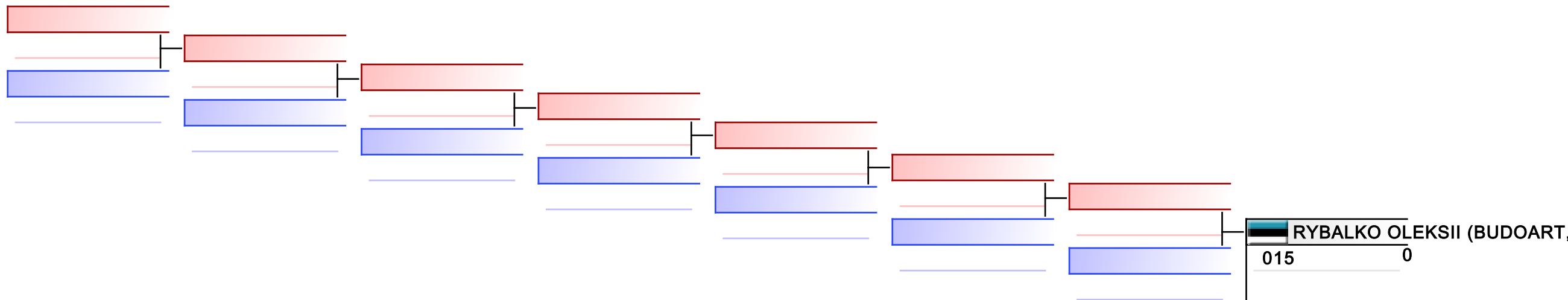

REPECHAGE: (1)

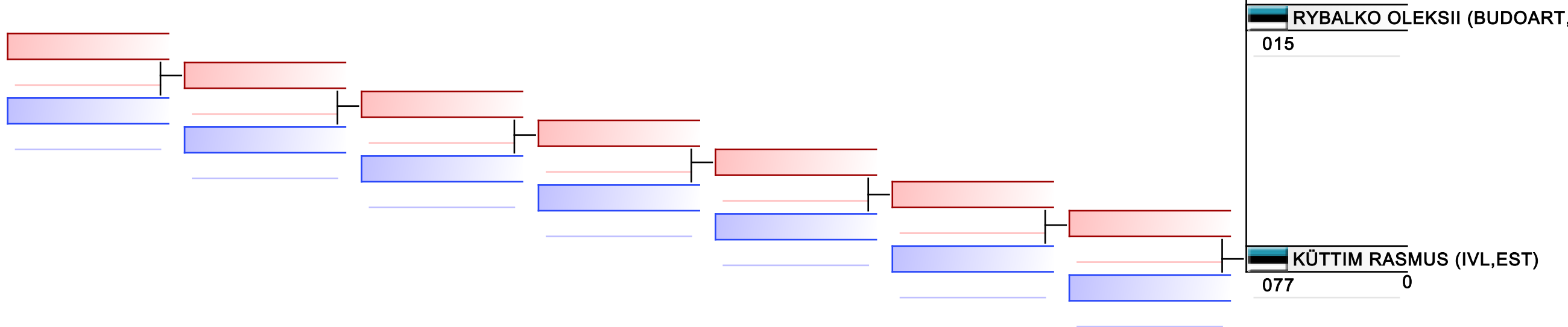

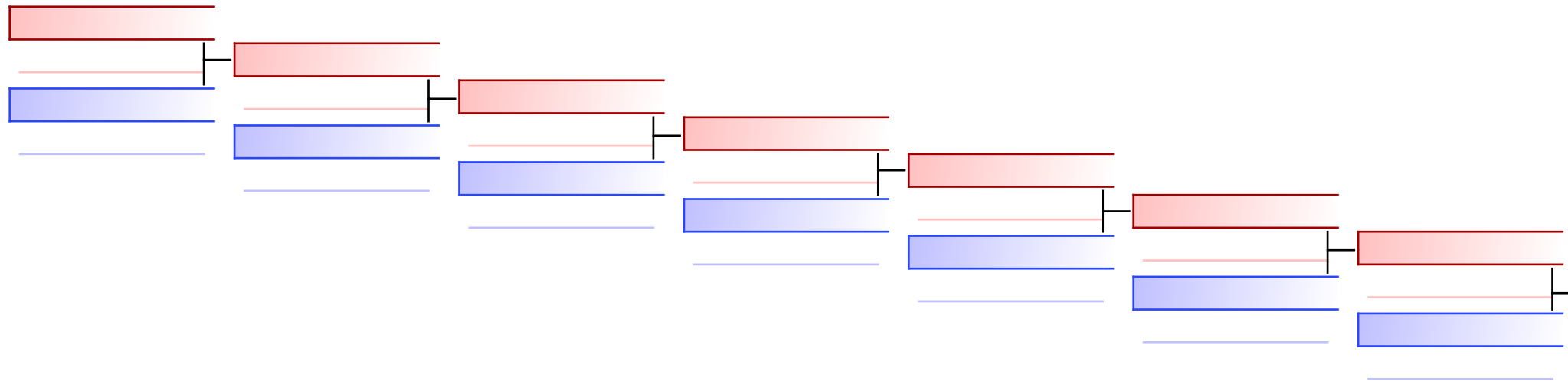

	REBANE REINHOLD (RIVETA, E)
107	Annan 5

REPECHAGE: (1)

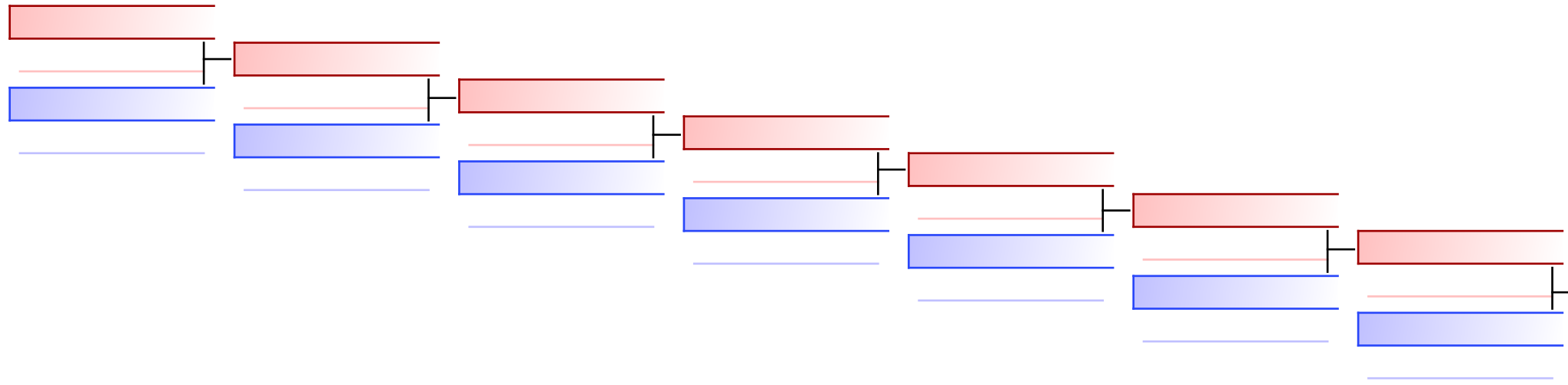

	REBANE REINHOLD (RIVETA, E)
107	

	ARRO ARO_ARGO (IMPACT, ES)
063	0

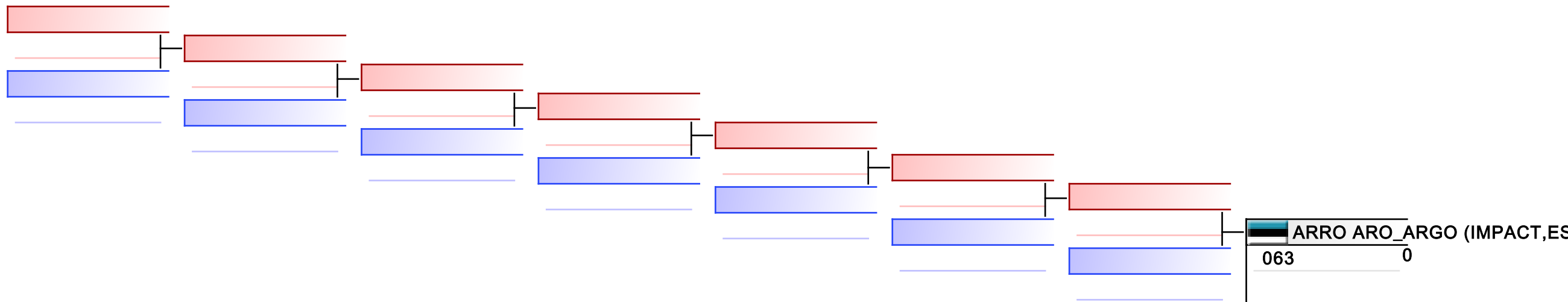

REPECHAGE: (1)

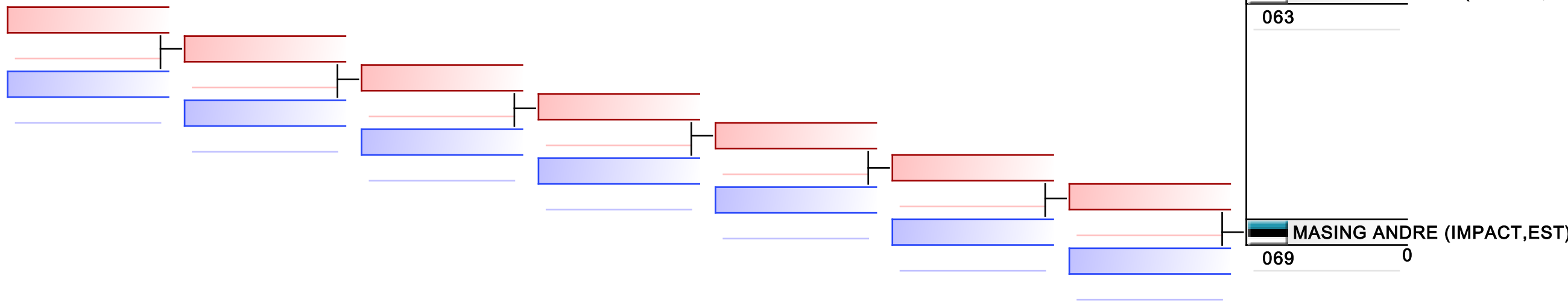

M U16 -52 kg

Corpore cup 2021

Tatami
2 14:25

Pool
1

(c)sportdata GmbH & Co KG 2000-2021(2021-09-25 16:36) -WKF Approved- v 9.8.7 build 3 (2020-09-25) License: Estonian Karate Federation (expire 2022-11-29)

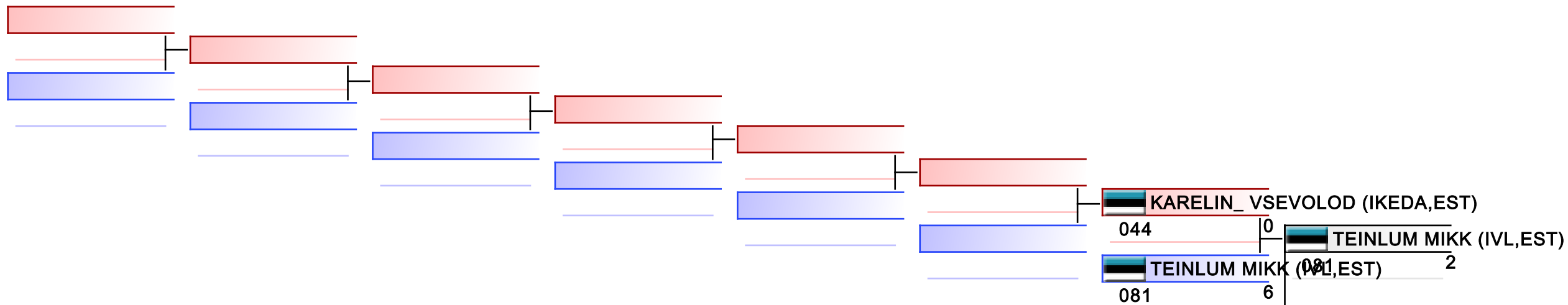

REPECHAGE: (1)

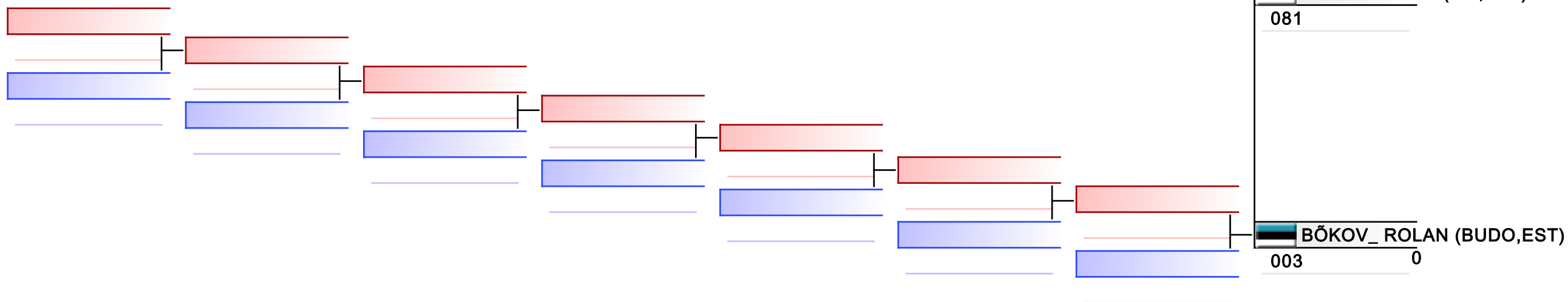

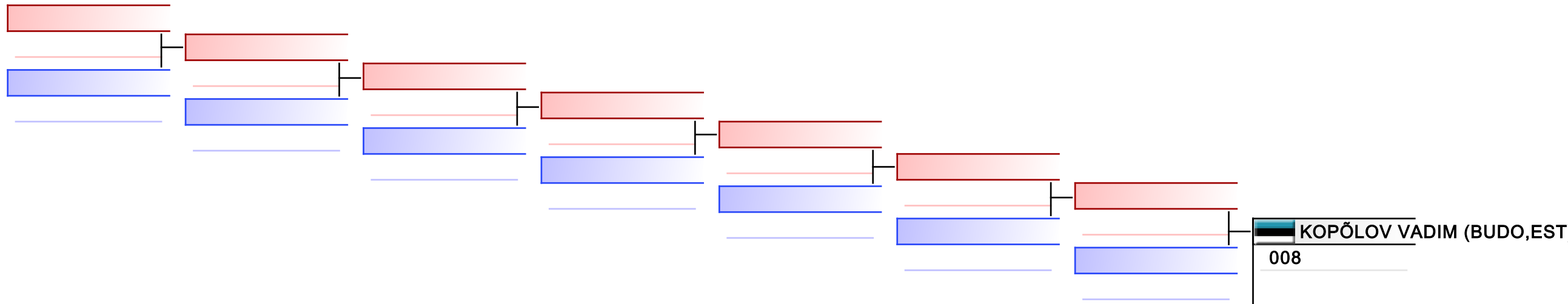

REPECHAGE: (1)

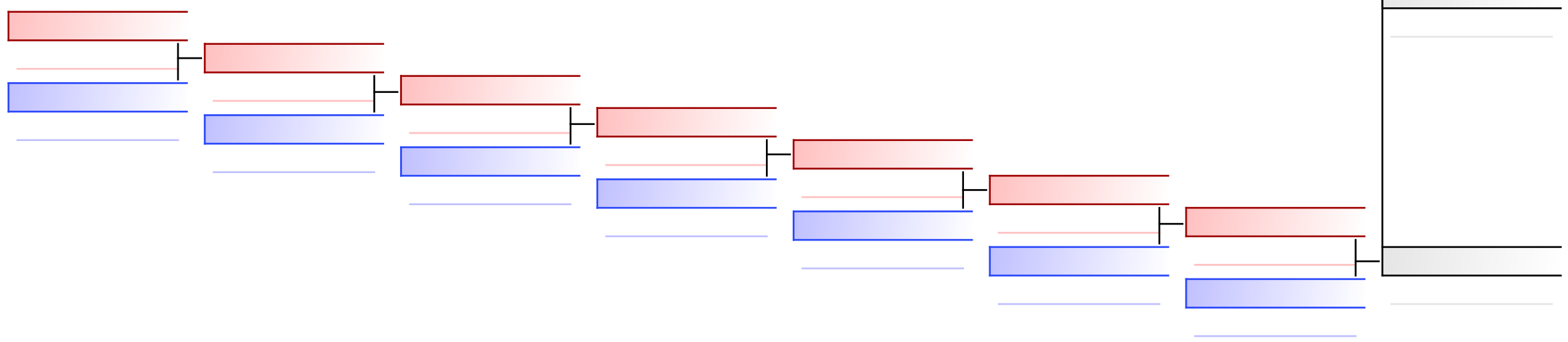

M U16 Open
Corpore cup 2021

Tatami
2 15:45

Pool
1

(c)sportdata GmbH & Co KG 2000-2021(2021-09-25 16:36) -WKF Approved- v 9.8.7 build 3 (2020-09-25) License: Estonian Karate Federation (expire 2022-11-29)

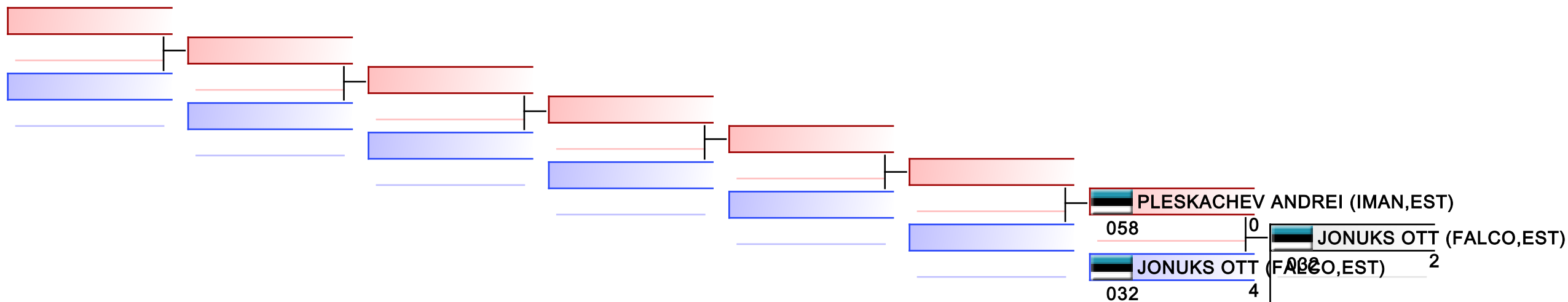

REPECHAGE: (1)

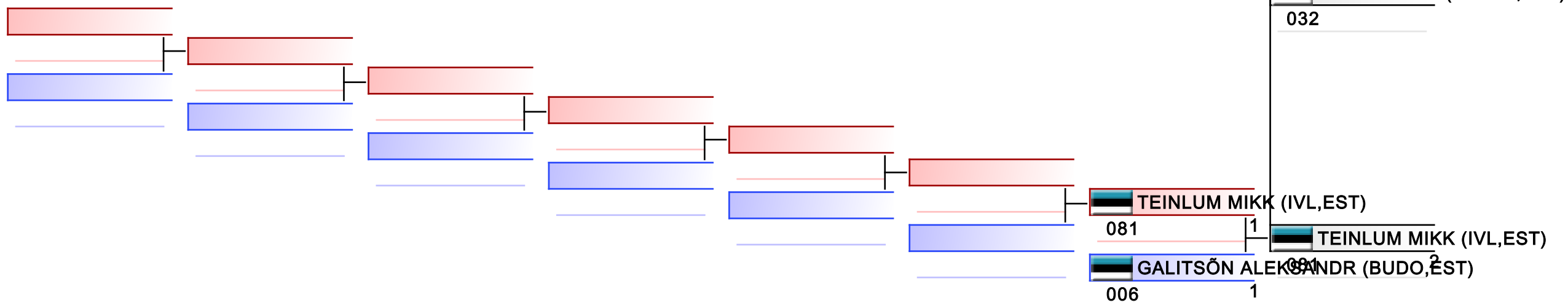

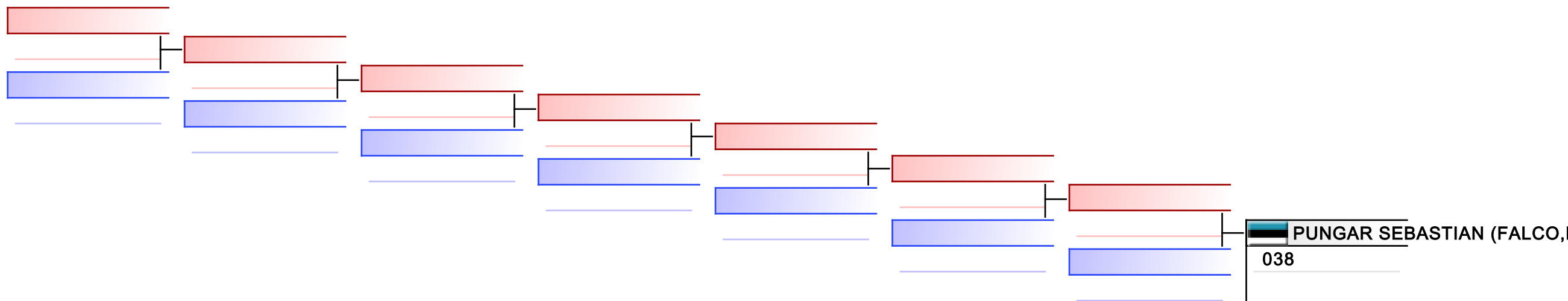

REPECHAGE: (1)

