

F U12 +40 kg

EKF klubide MV 2021

Tatami

Pool

1

(c)sportdata GmbH & Co KG 2000-2021(2021-10-16 19:18) -WKF Approved- v 9.8.7 build 3 (2020-09-25) License: Estonian Karate Federation (expire 2022-11-29)

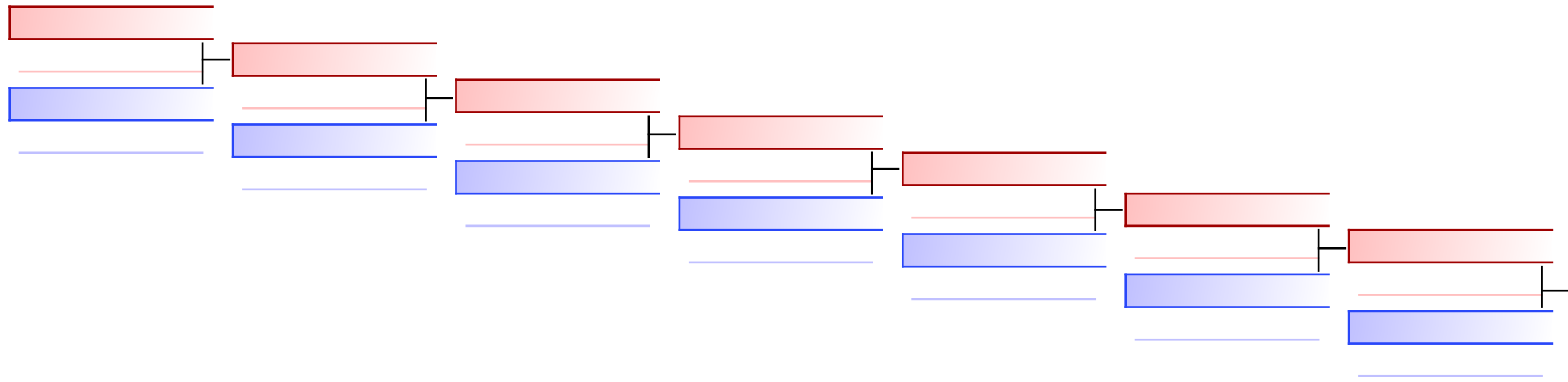

REPECHAGE: (1)

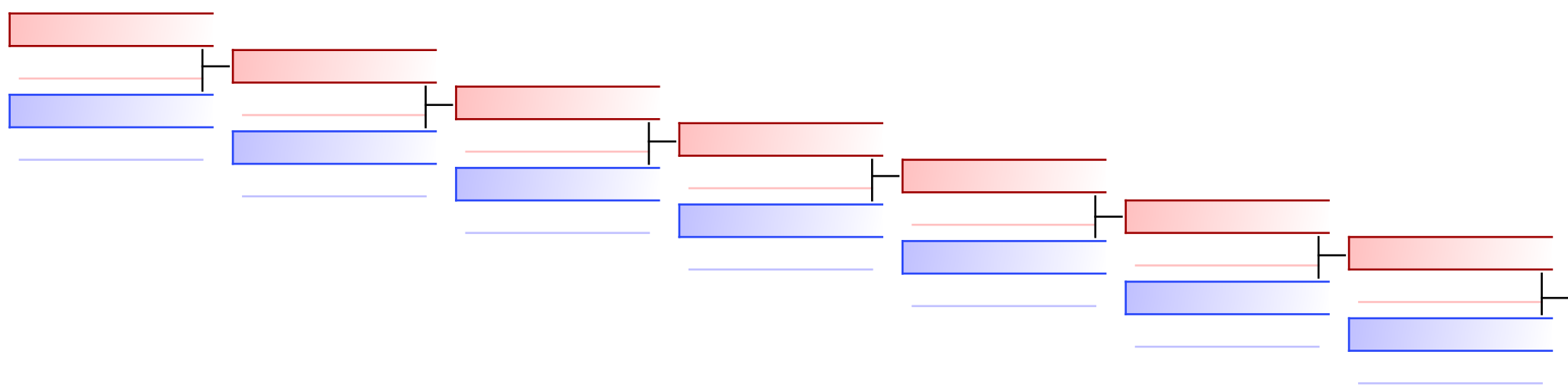

PODHODJASTSEVA DARINA (EDU-D
051 2

TOOMPERE CAROL (IMPACT)
117

TOOMPERE CAROL (IMPACT)
117 5

Referees:							
-----------	--	--	--	--	--	--	--

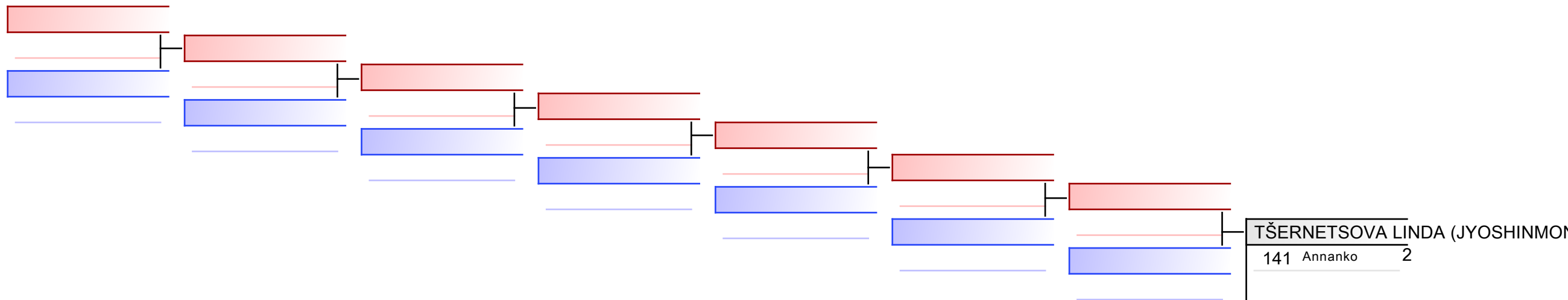

REPECHAGE: (1)

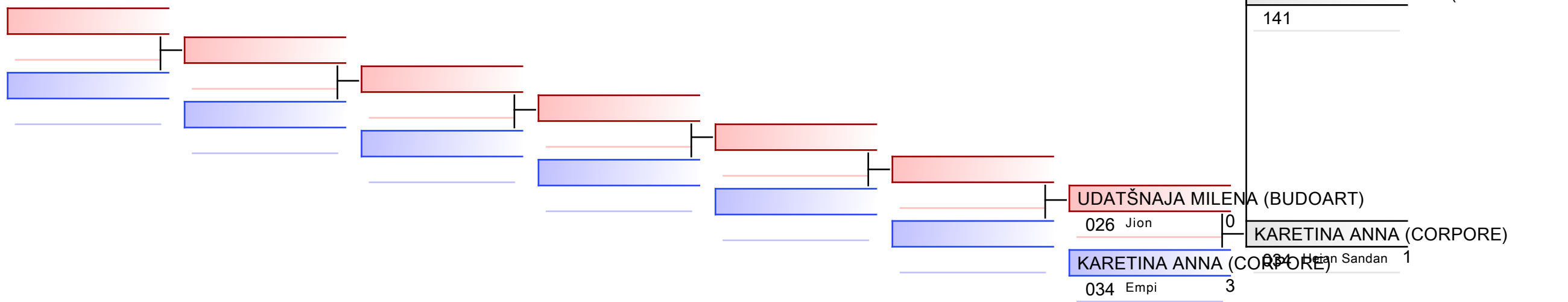

Referees:							
-----------	--	--	--	--	--	--	--

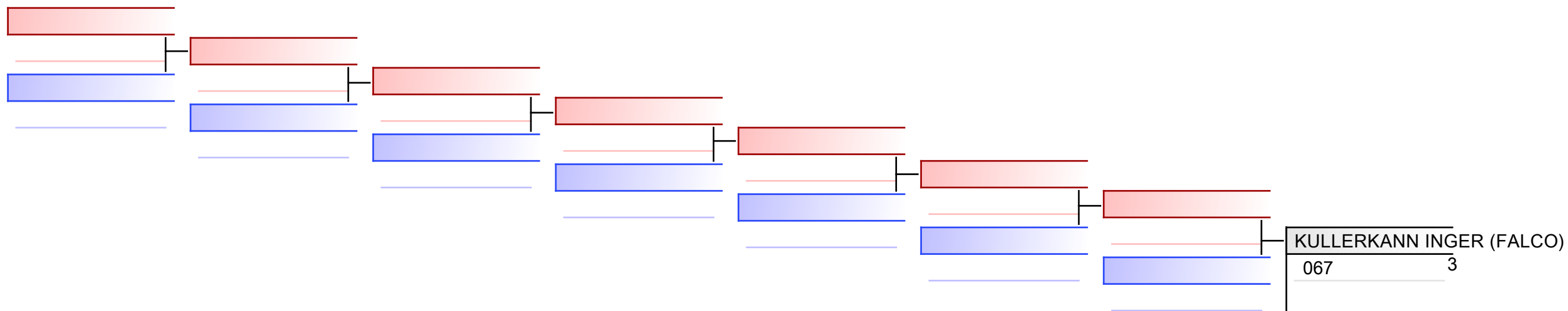

REPECHAGE: (1)

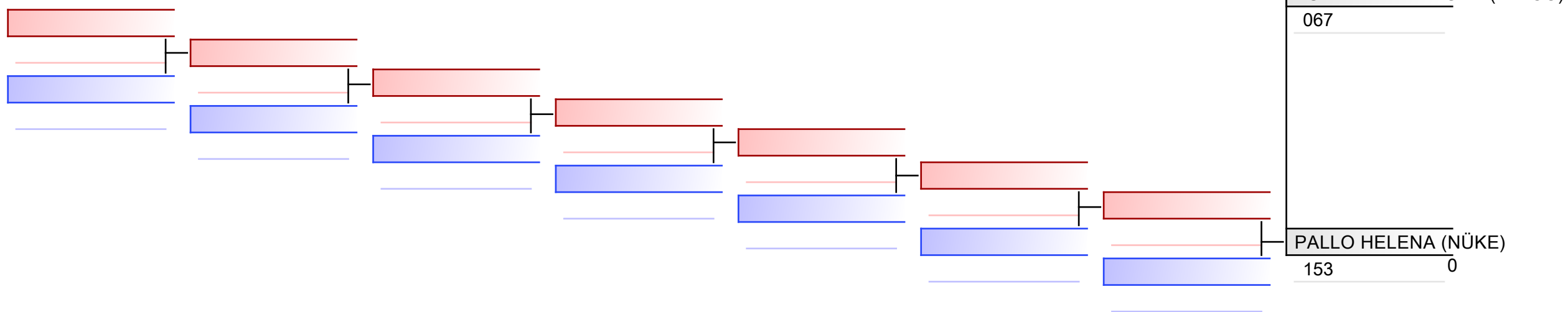

Referees:							
-----------	--	--	--	--	--	--	--

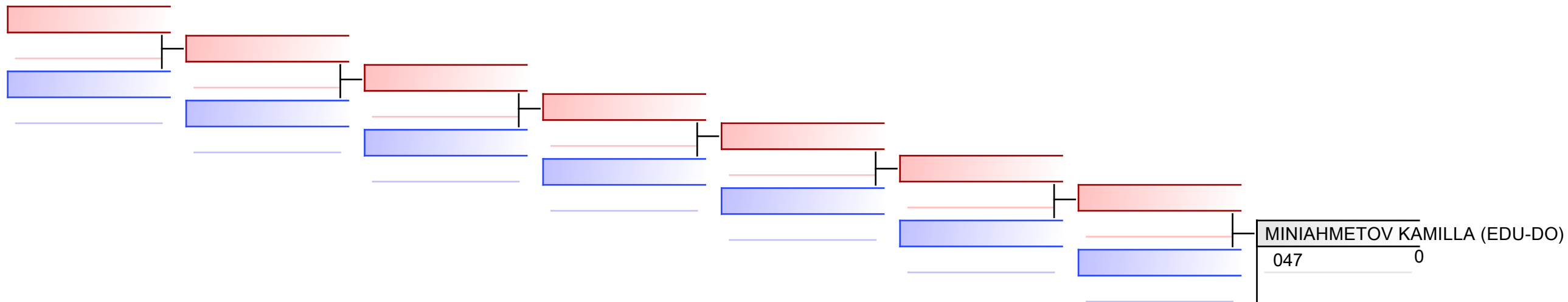

REPECHAGE: (1)

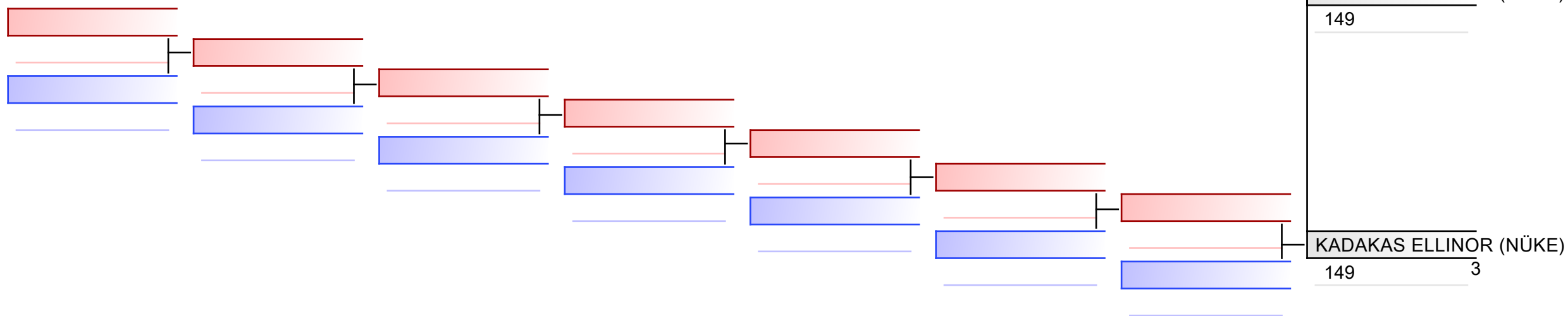

Referees:							
-----------	--	--	--	--	--	--	--

F U14 kata

EKF klubide MV 2021

(c)sportdata GmbH & Co KG 2000-2021(2021-10-16 19:18) -WKF Approved- v 9.8.7 build 3 (2020-09-25) License: Estonian Karate Federation (expire 2022-11-29)

Tatami

Pool

1

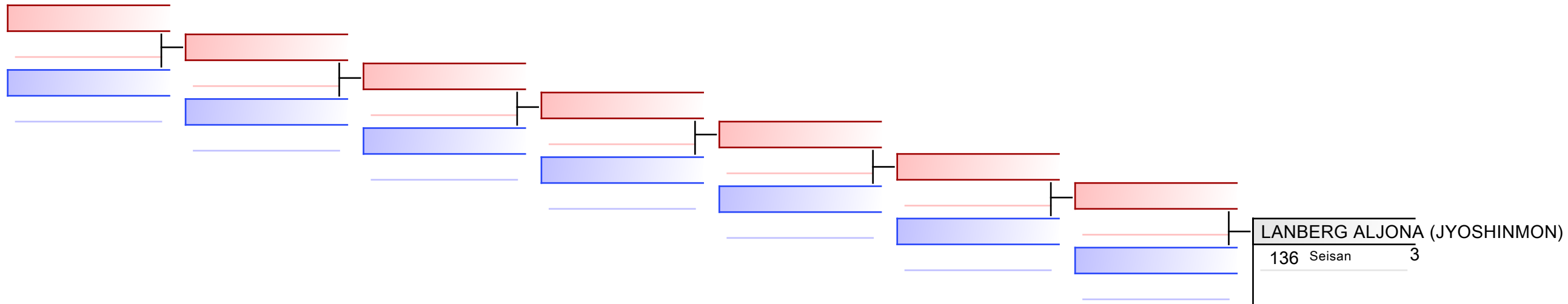

REPECHAGE: (1)

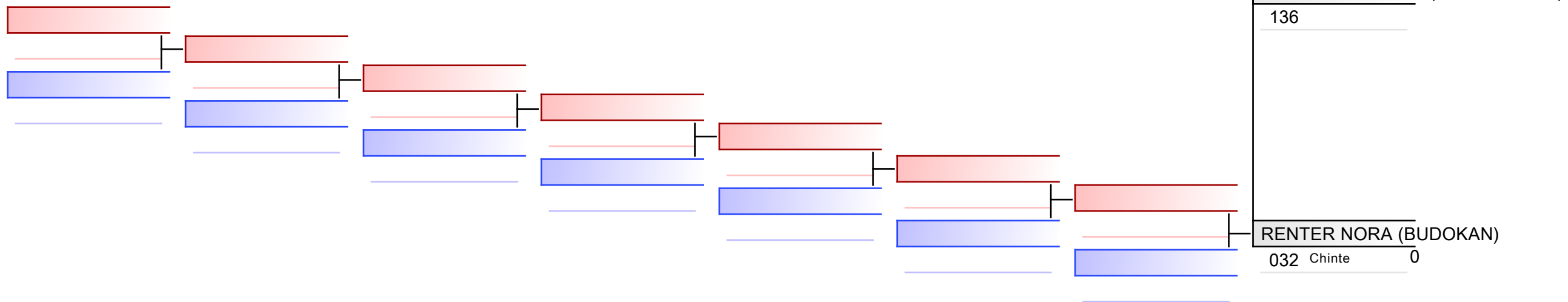

Referees:							
-----------	--	--	--	--	--	--	--

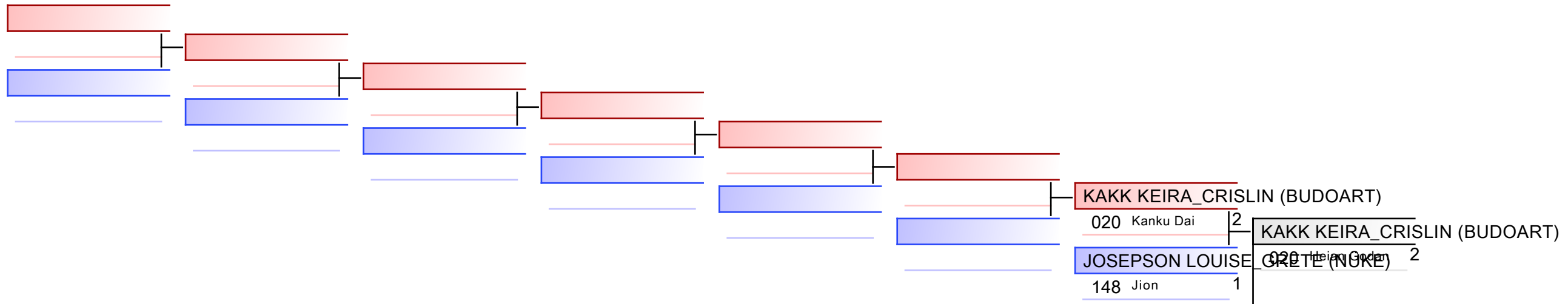

REPECHAGE: (1)

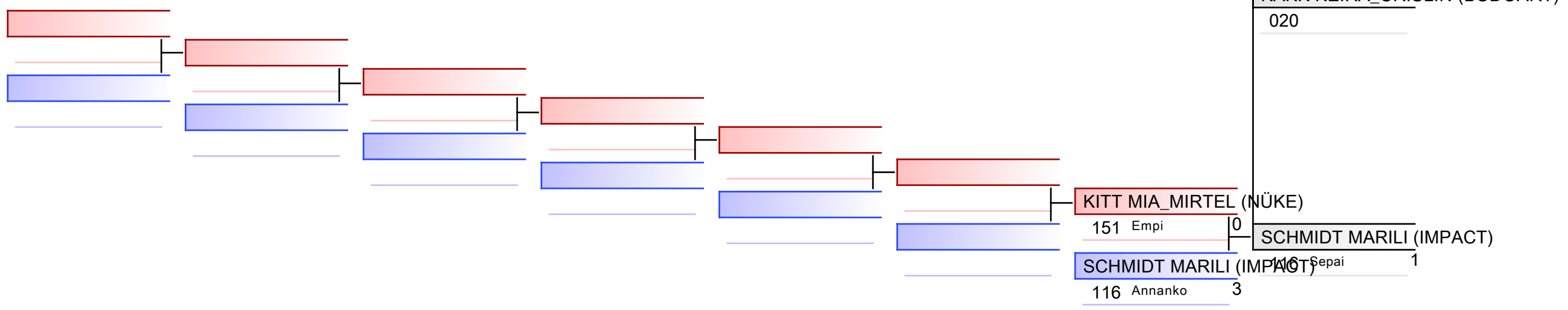

Referees:							
-----------	--	--	--	--	--	--	--

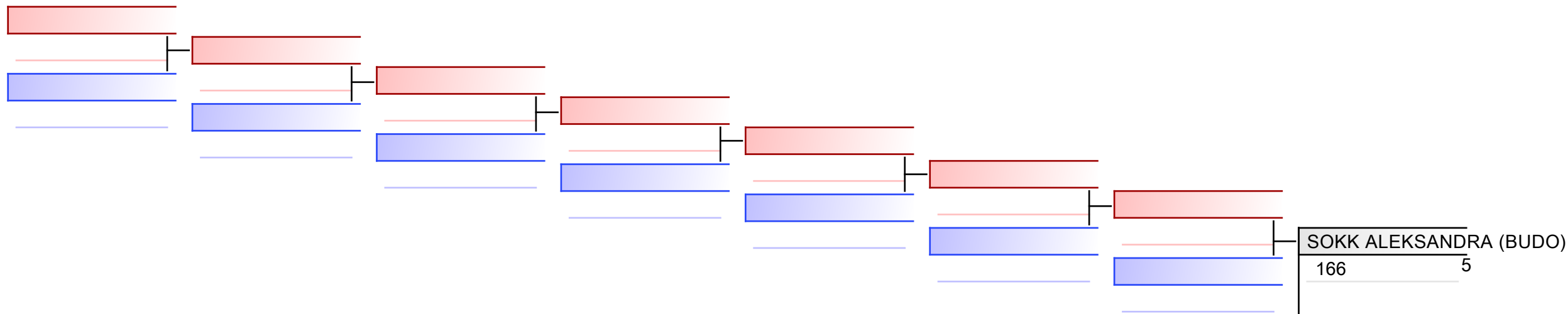

REPECHAGE: (1)

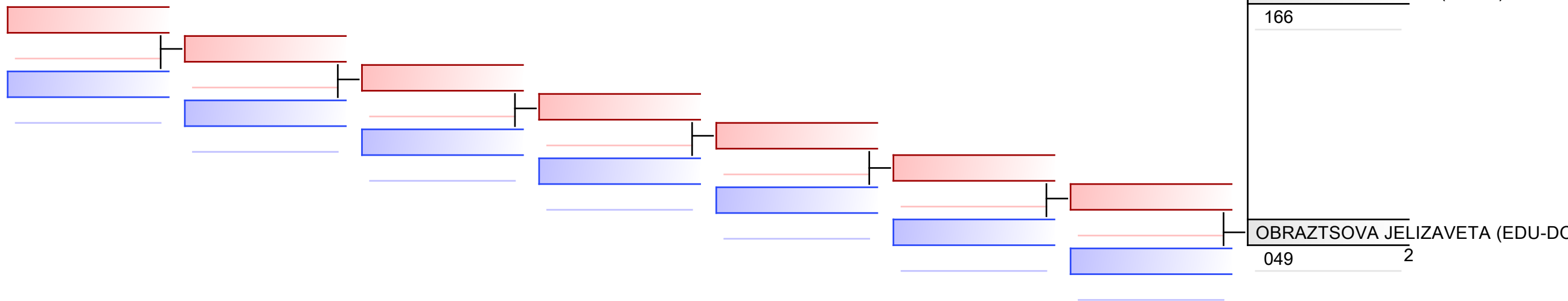

Referees:							
-----------	--	--	--	--	--	--	--

Female kata

EKF klubide MV 2021

Tatami
1 15:30

Pool
1

(c)sportdata GmbH & Co KG 2000-2021(2021-10-16 19:18) -WKF Approved- v 9.8.7 build 3 (2020-09-25) License: Estonian Karate Federation (expire 2022-11-29)

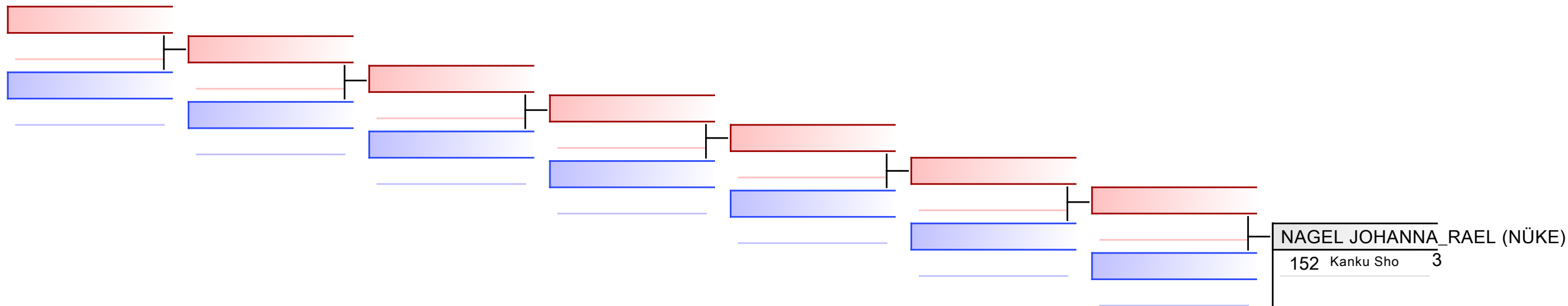

REPECHAGE: (1)

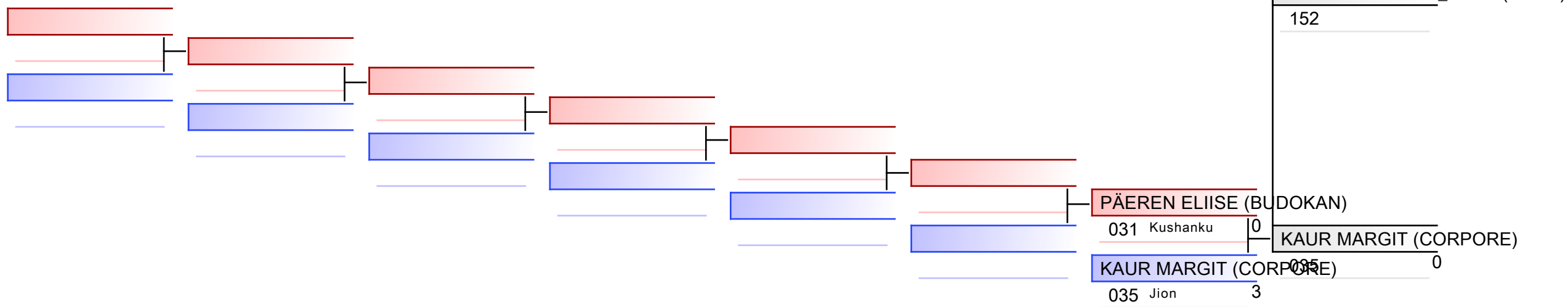

Referees:							
-----------	--	--	--	--	--	--	--

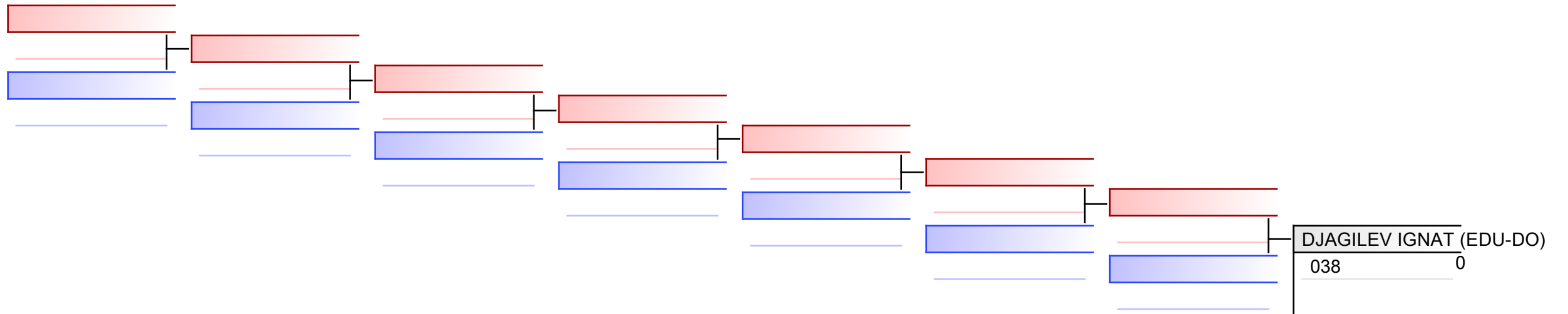

REPECHAGE: (1)

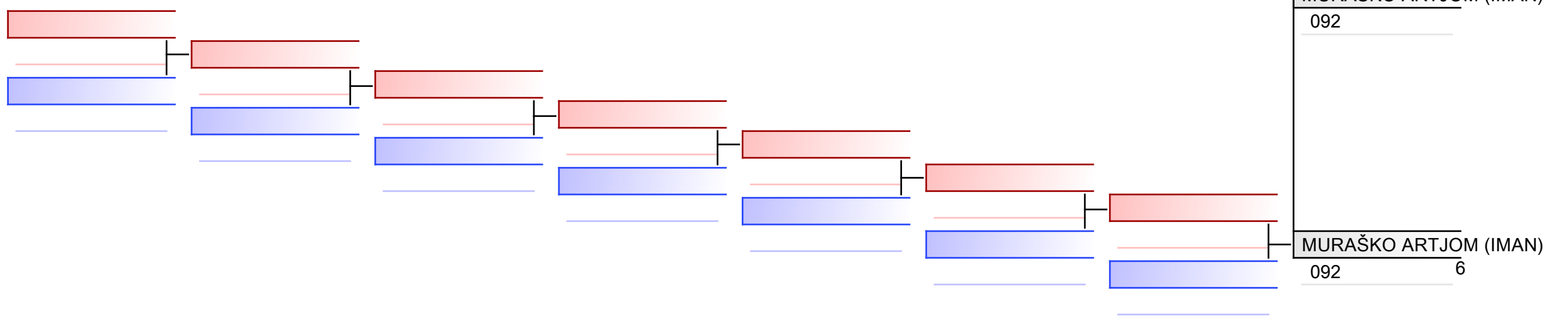

Referees:							
-----------	--	--	--	--	--	--	--

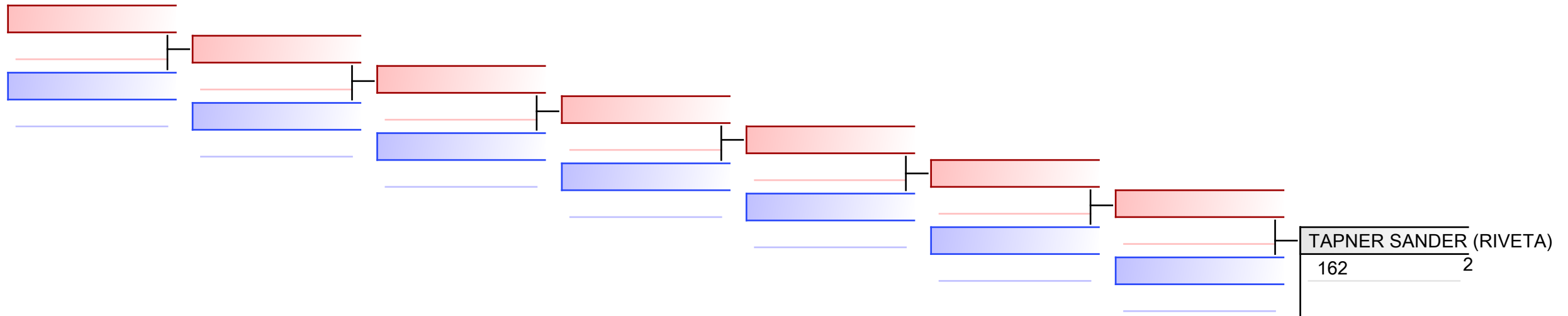

REPECHAGE: (1)

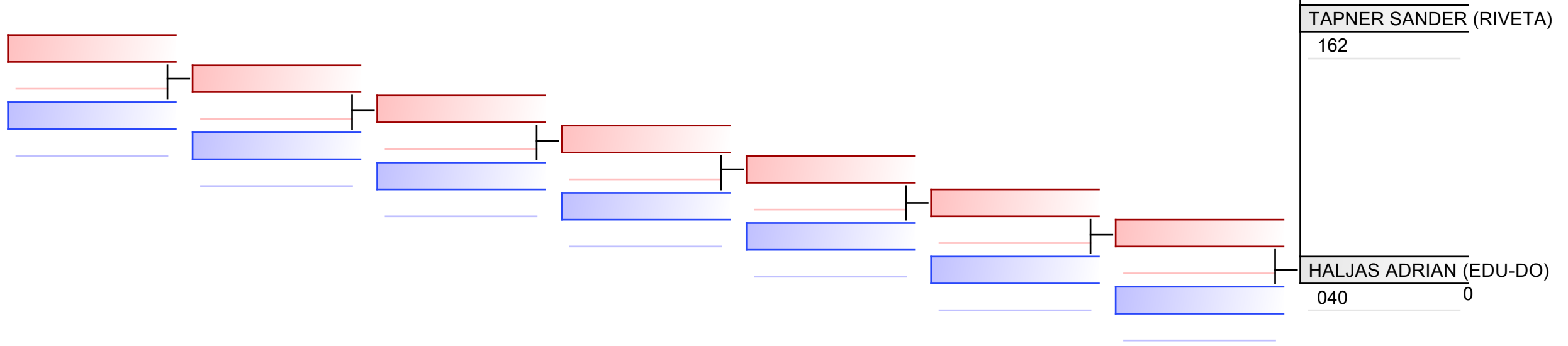

Referees:							
-----------	--	--	--	--	--	--	--

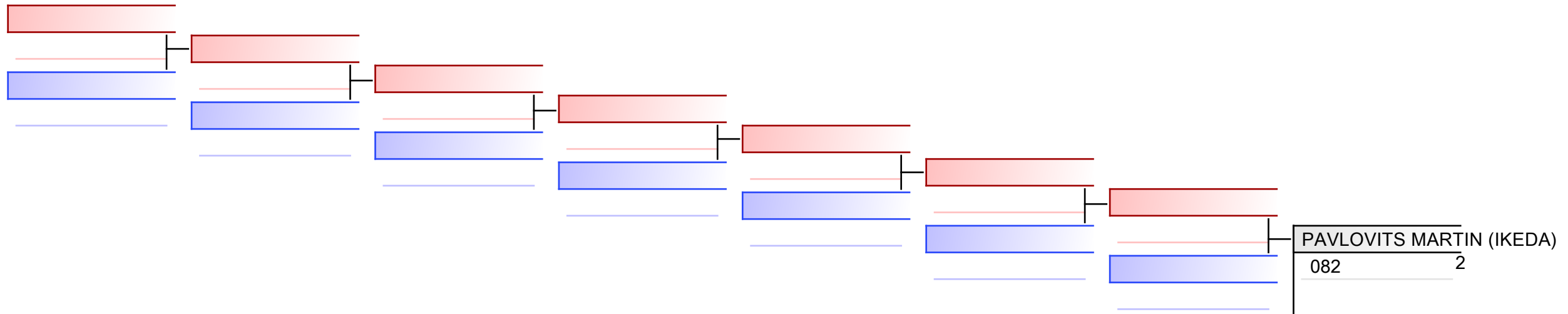

REPECHAGE: (1)

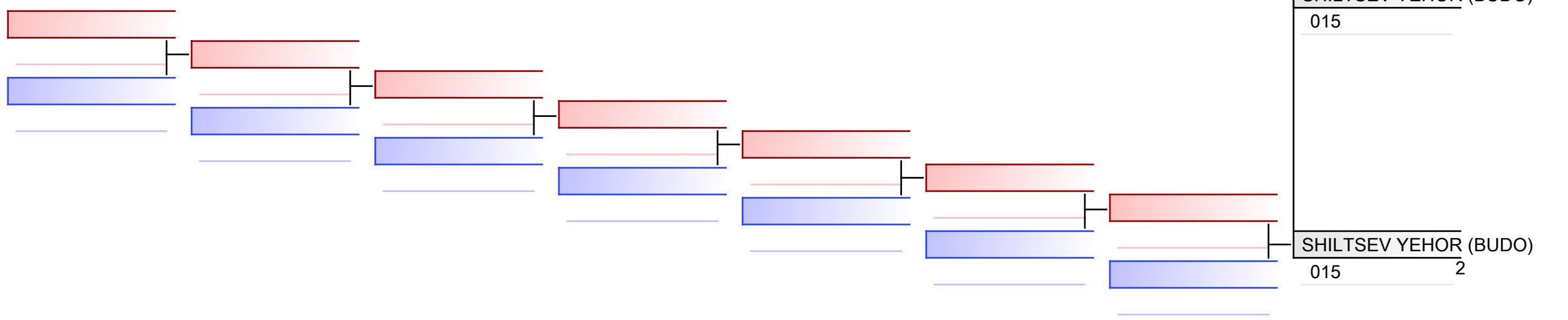

Referees:							
-----------	--	--	--	--	--	--	--

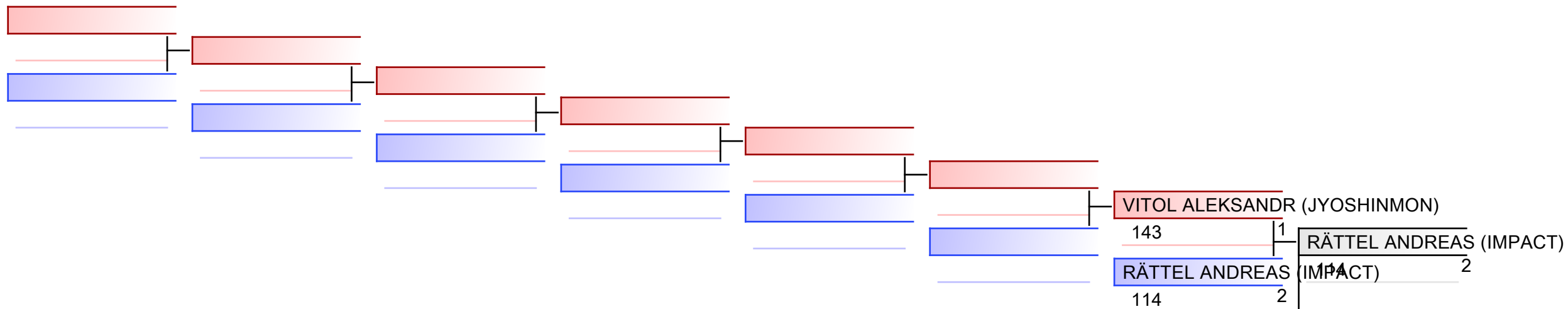

REPECHAGE: (1)

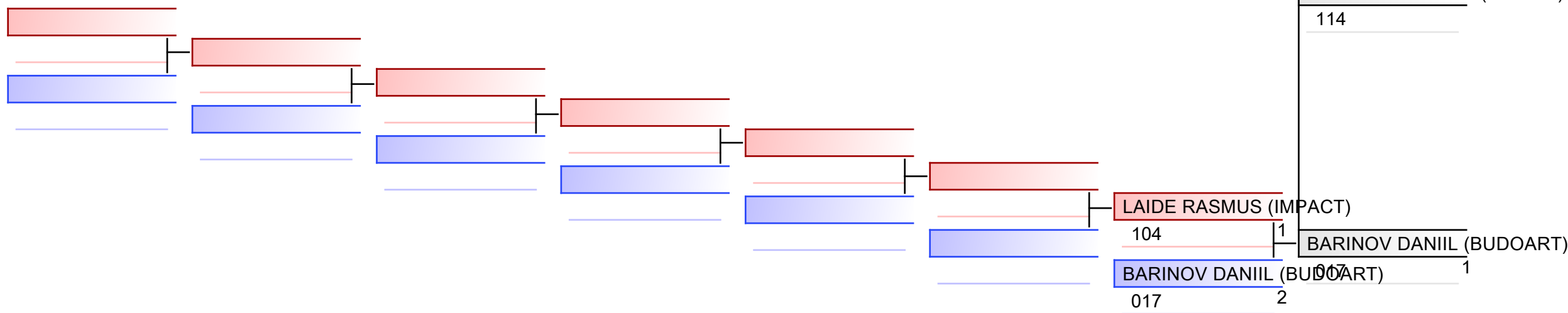

Referees:							
-----------	--	--	--	--	--	--	--

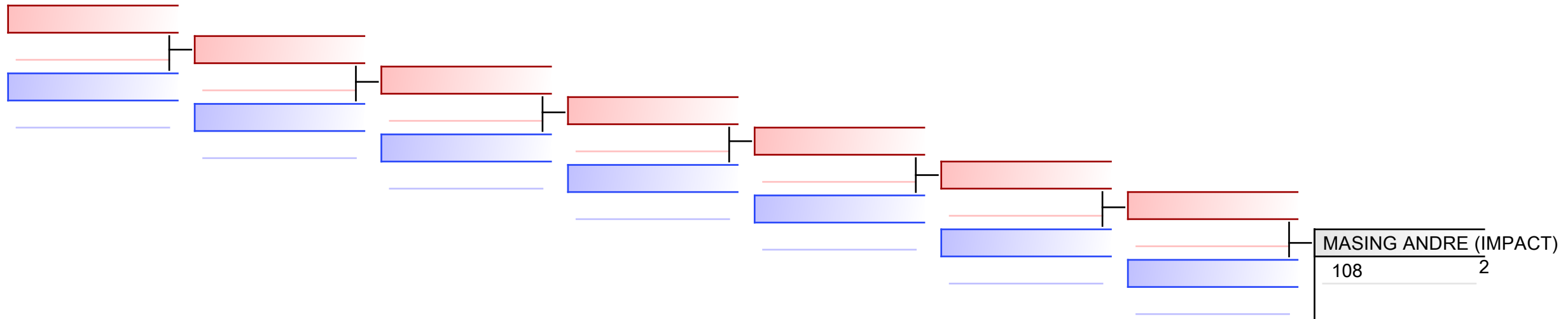

REPECHAGE: (1)

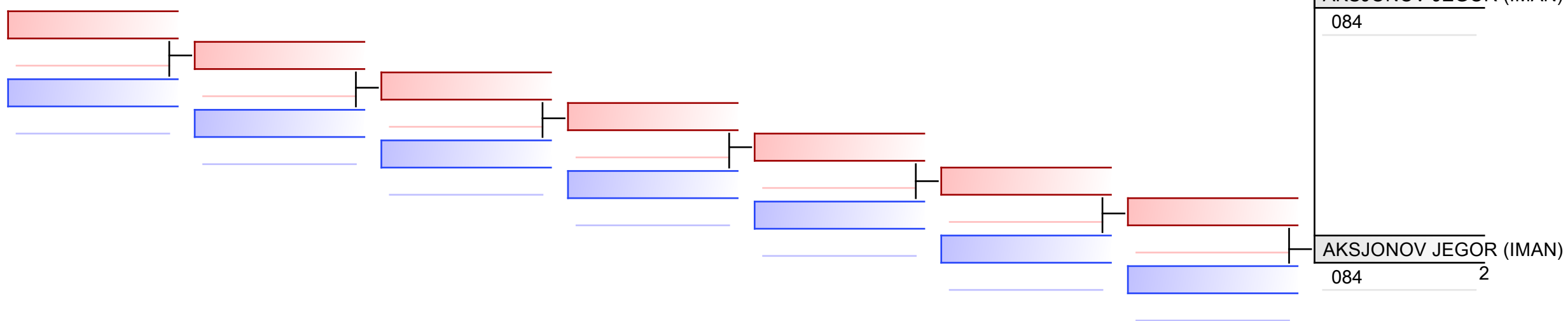

Referees:							
-----------	--	--	--	--	--	--	--

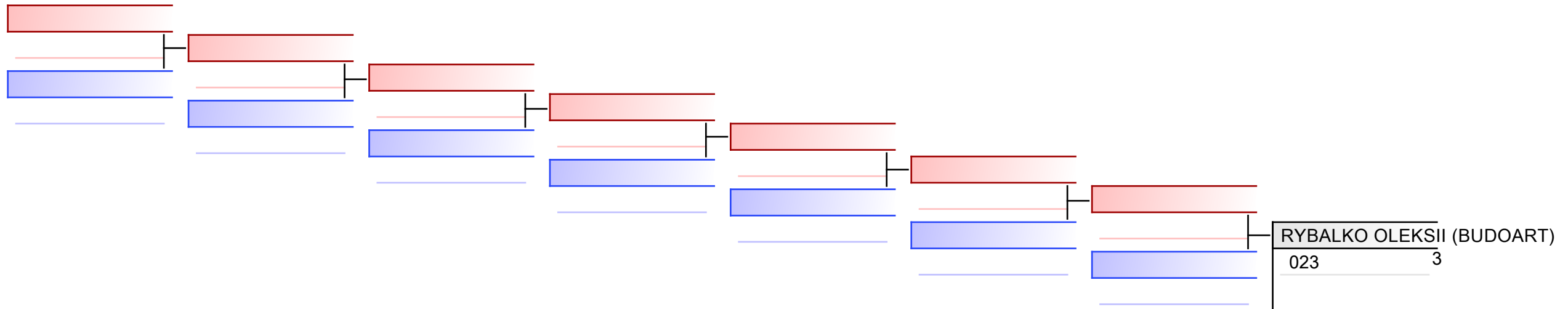

REPECHAGE: (1)

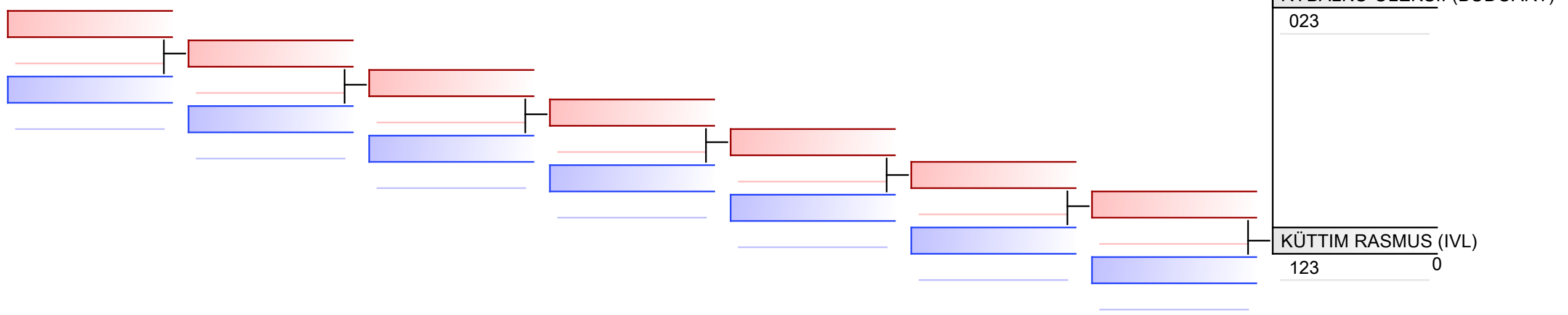

Referees:							
-----------	--	--	--	--	--	--	--

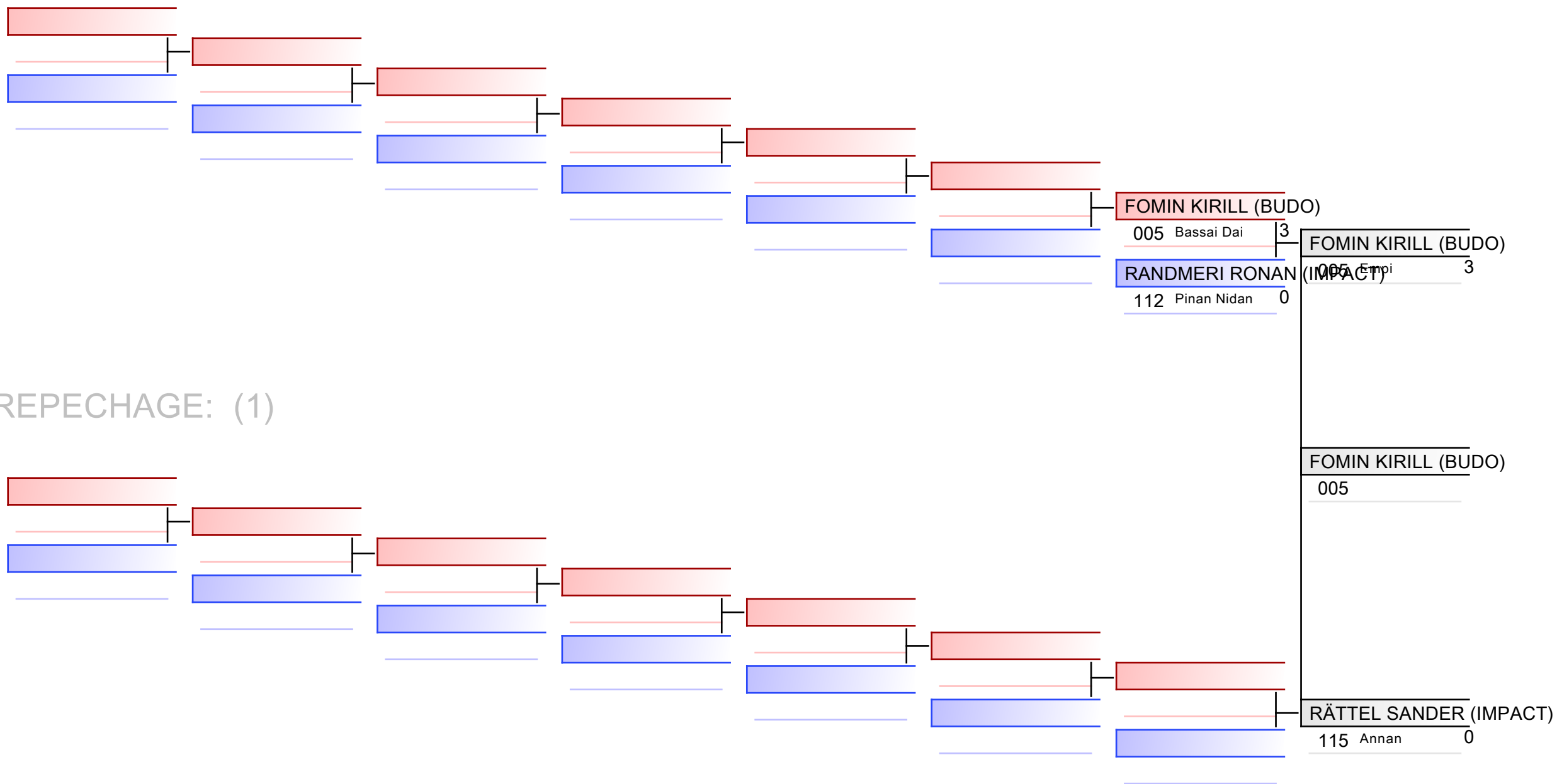

Referees:							
-----------	--	--	--	--	--	--	--

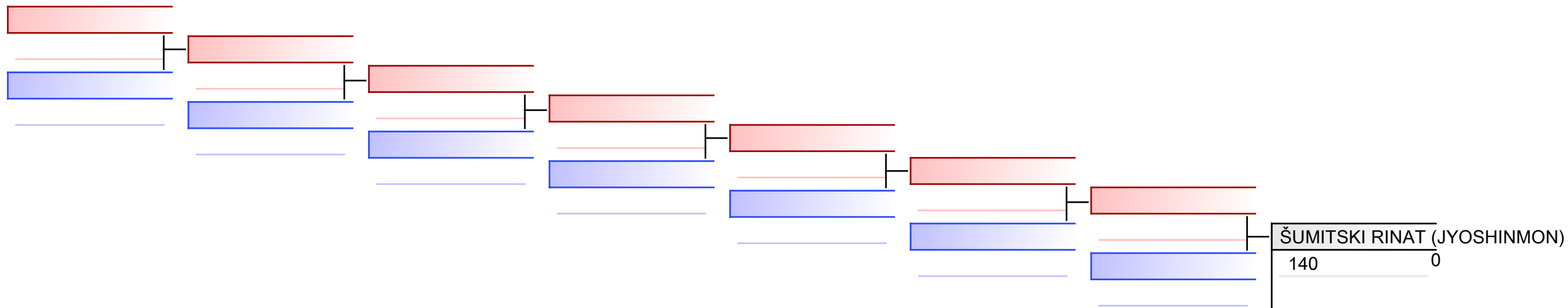

REPECHAGE: (1)

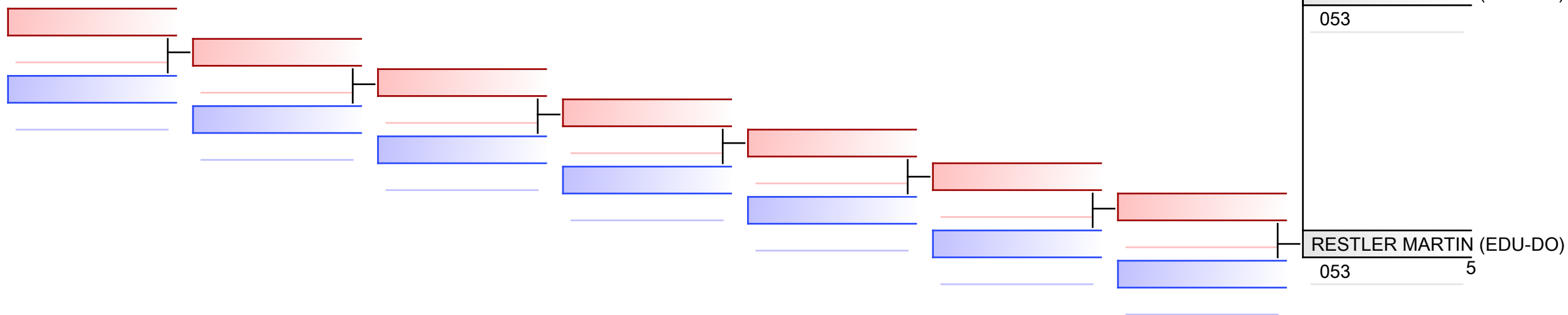

Referees:							
-----------	--	--	--	--	--	--	--

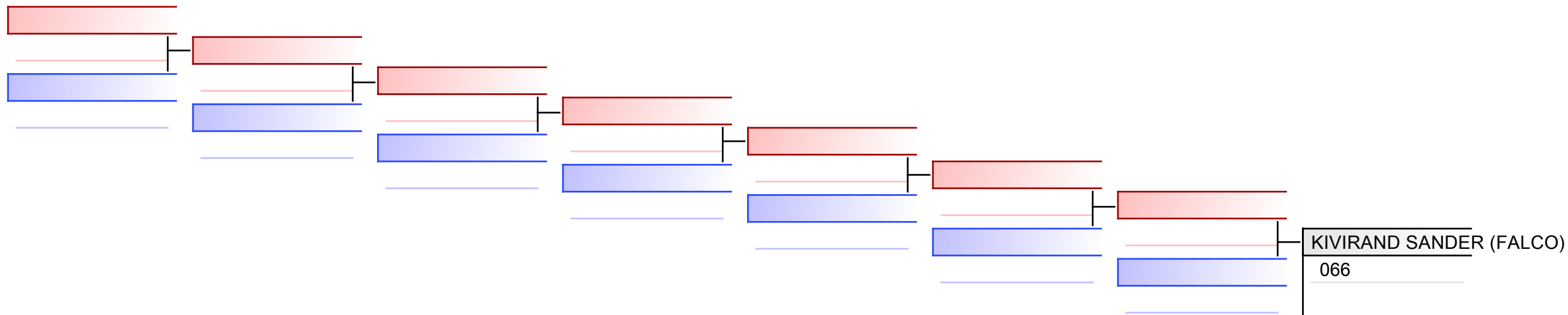

REPECHAGE: (1)

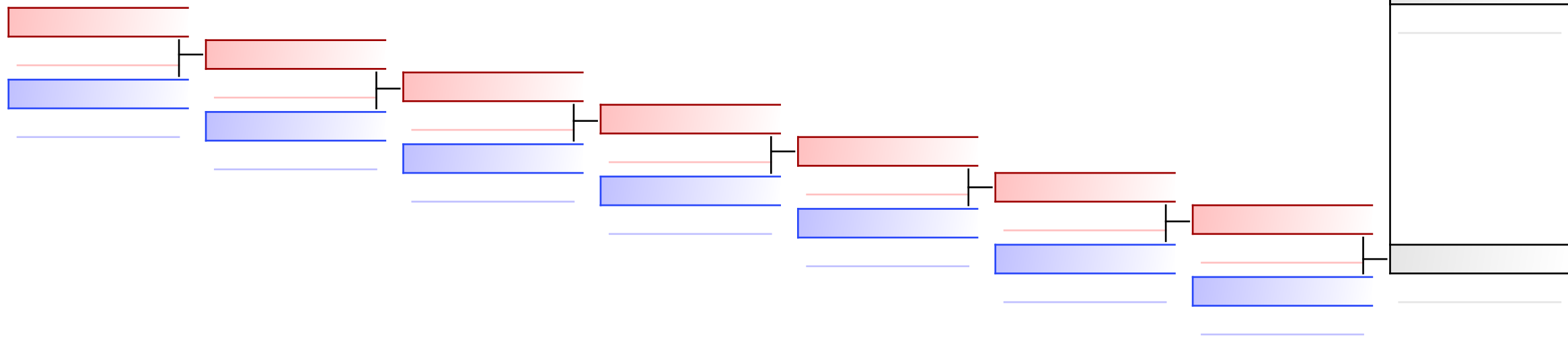

Referees:							
-----------	--	--	--	--	--	--	--

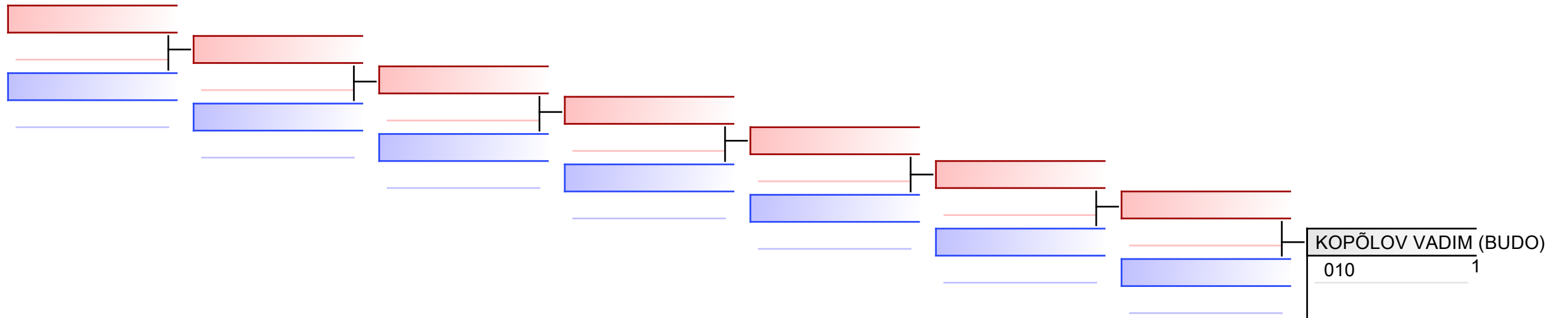

REPECHAGE: (1)

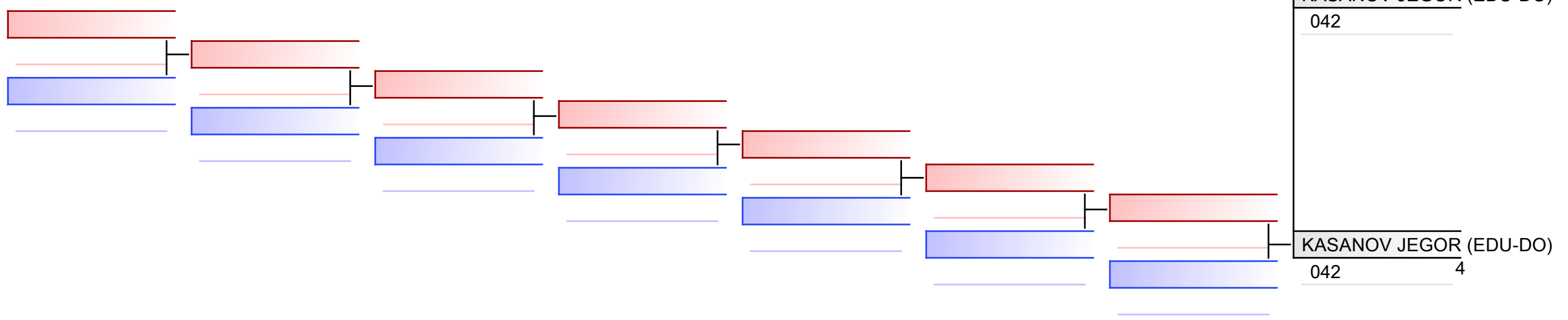

Referees:							
-----------	--	--	--	--	--	--	--

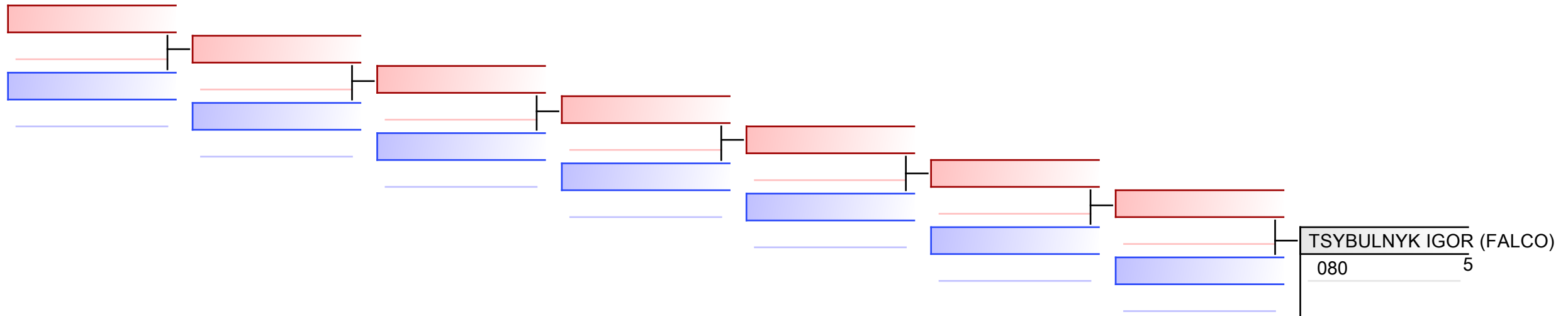

REPECHAGE: (1)

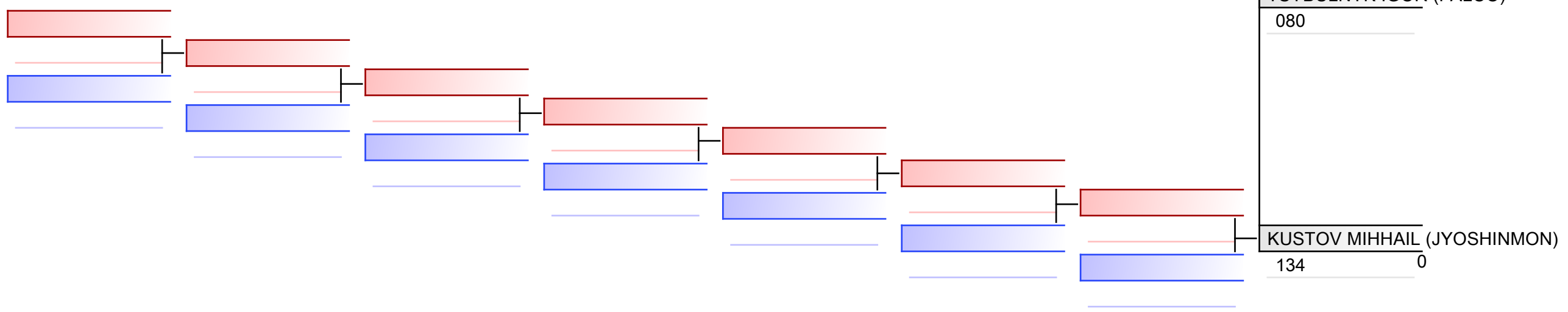

Referees:							
-----------	--	--	--	--	--	--	--

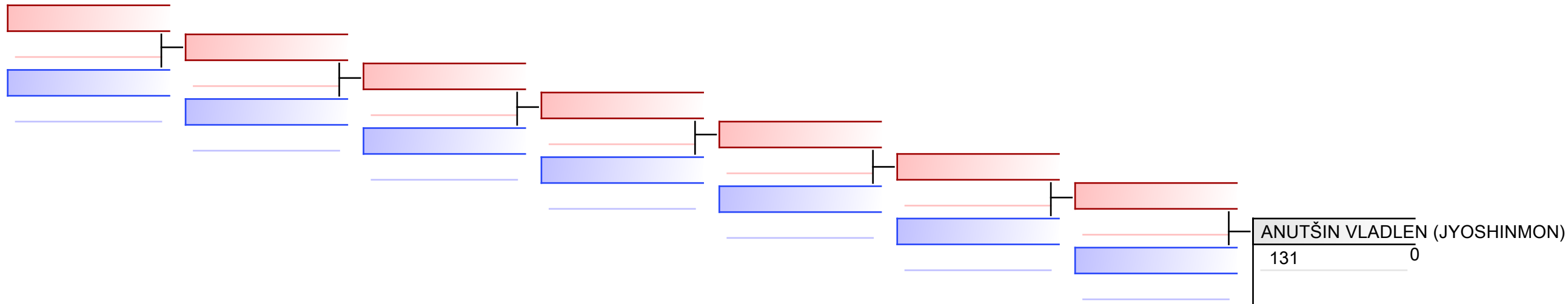

REPECHAGE: (1)

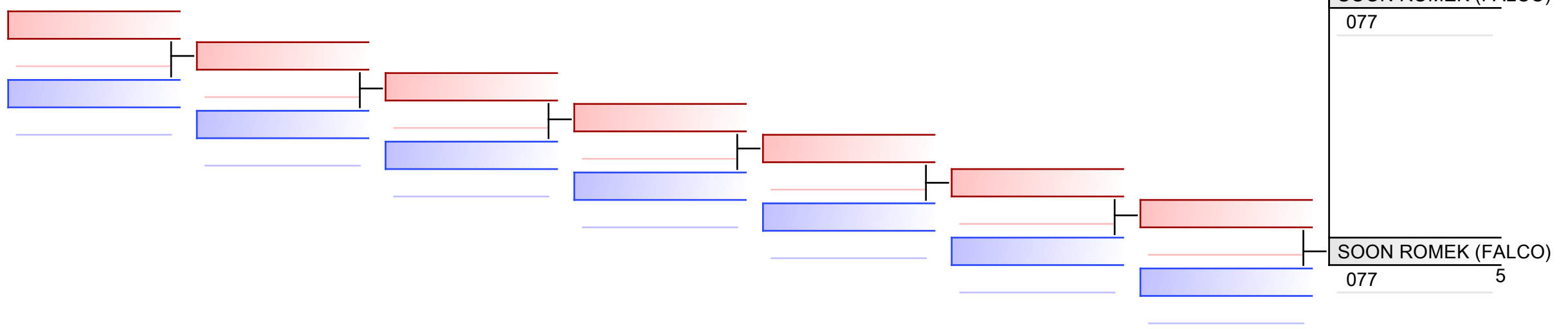

Referees:							
-----------	--	--	--	--	--	--	--

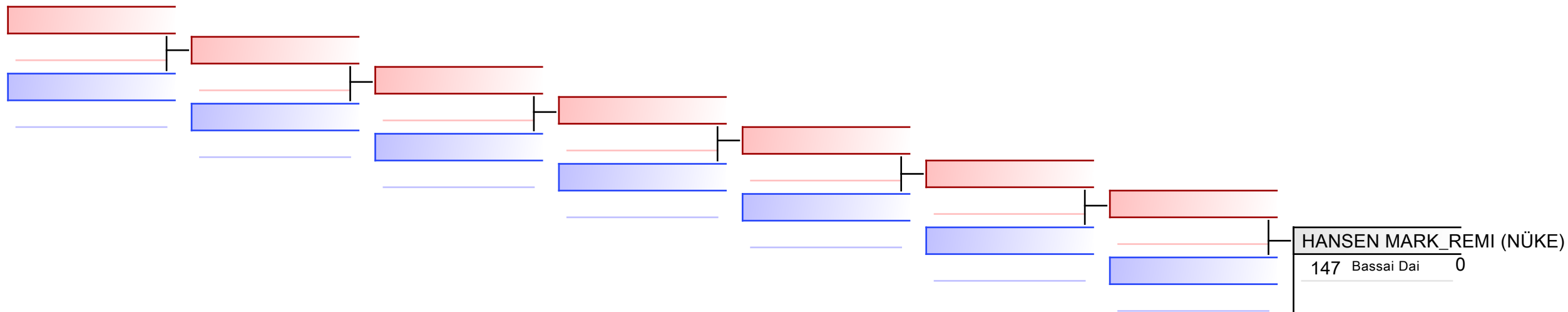

REPECHAGE: (1)

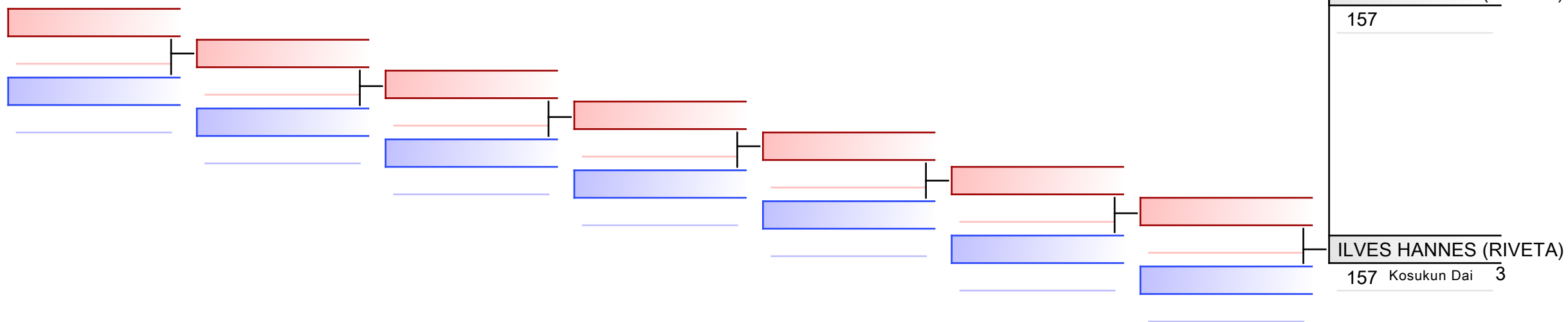

Referees:							
-----------	--	--	--	--	--	--	--

M U18 -76 kg

EKF klubide MV 2021

Tatami
2 16:35

Pool
1

(c)sportdata GmbH & Co KG 2000-2021(2021-10-16 19:18) -WKF Approved- v 9.8.7 build 3 (2020-09-25) License: Estonian Karate Federation (expire 2022-11-29)

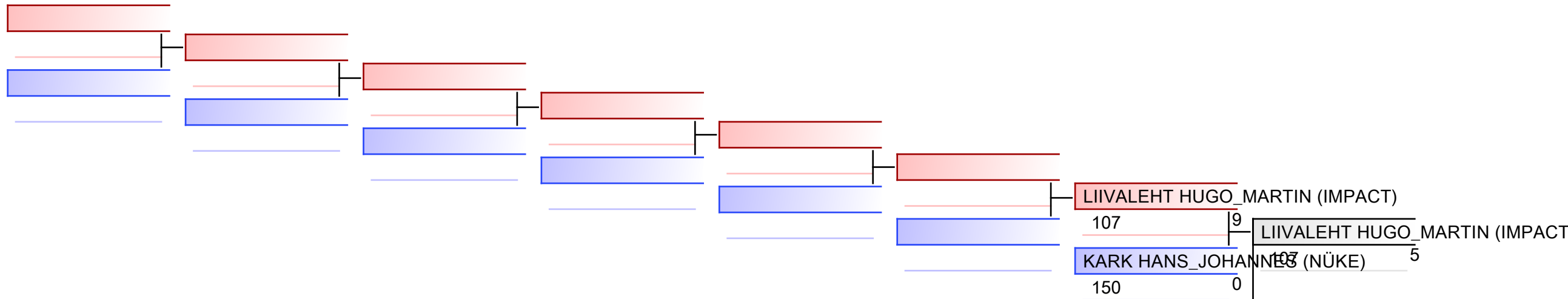

REPECHAGE: (1)

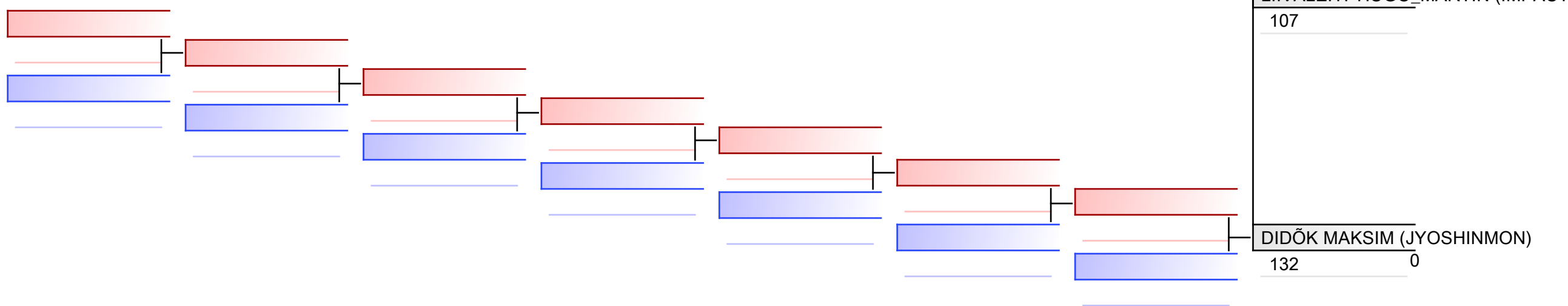

Referees:							
-----------	--	--	--	--	--	--	--

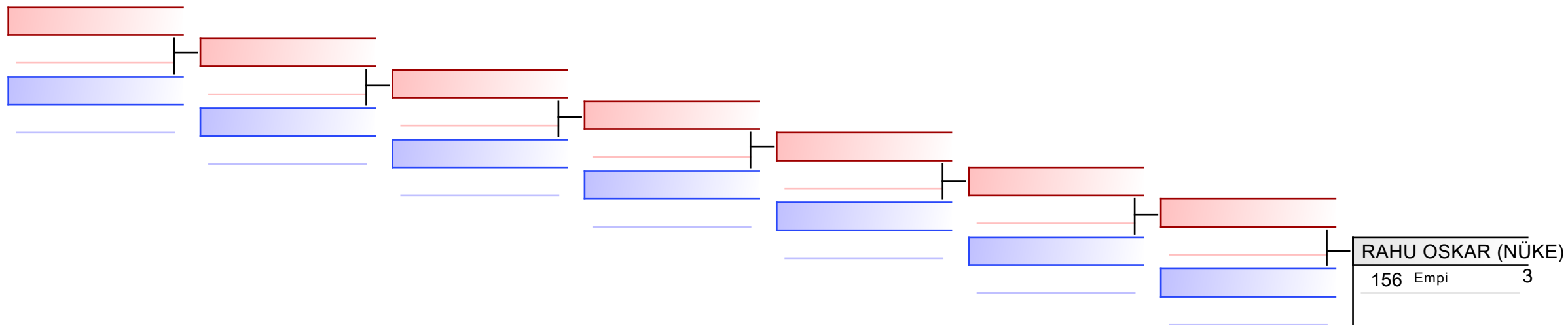

REPECHAGE: (1)

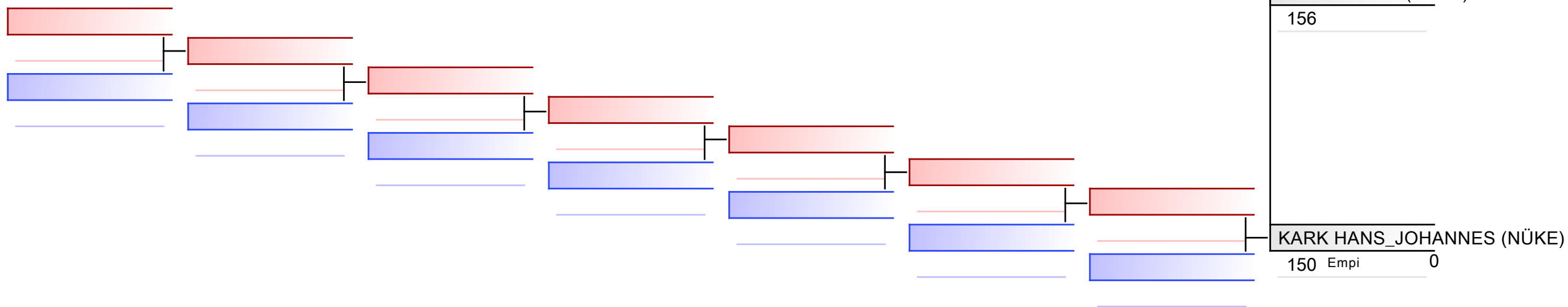

Referees:							
-----------	--	--	--	--	--	--	--

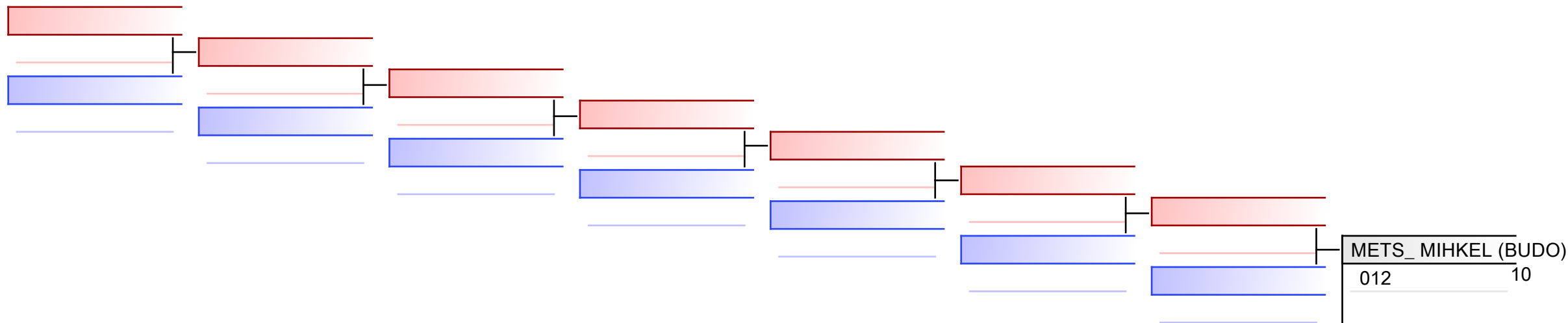

REPECHAGE: (1)

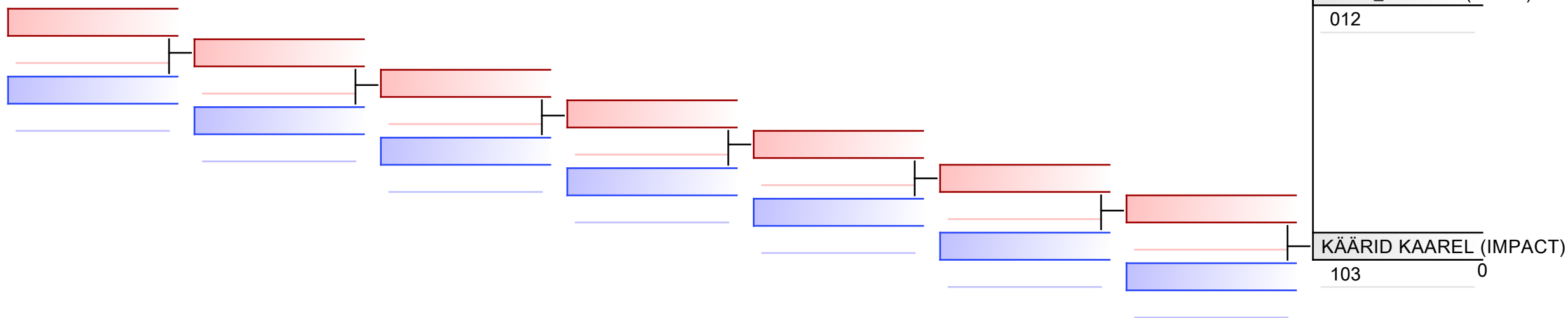

Referees:							
-----------	--	--	--	--	--	--	--

Male -67 kg

EKF klubide MV 2021

Tatami
2 17:45

Pool
1

(c)sportdata GmbH & Co KG 2000-2021(2021-10-16 19:18) -WKF Approved- v 9.8.7 build 3 (2020-09-25) License: Estonian Karate Federation (expire 2022-11-29)

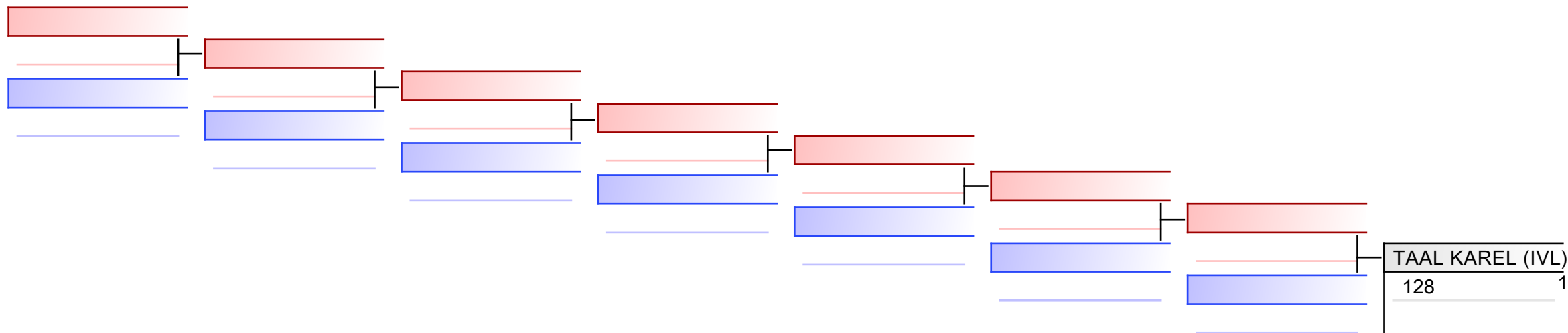

REPECHAGE: (1)

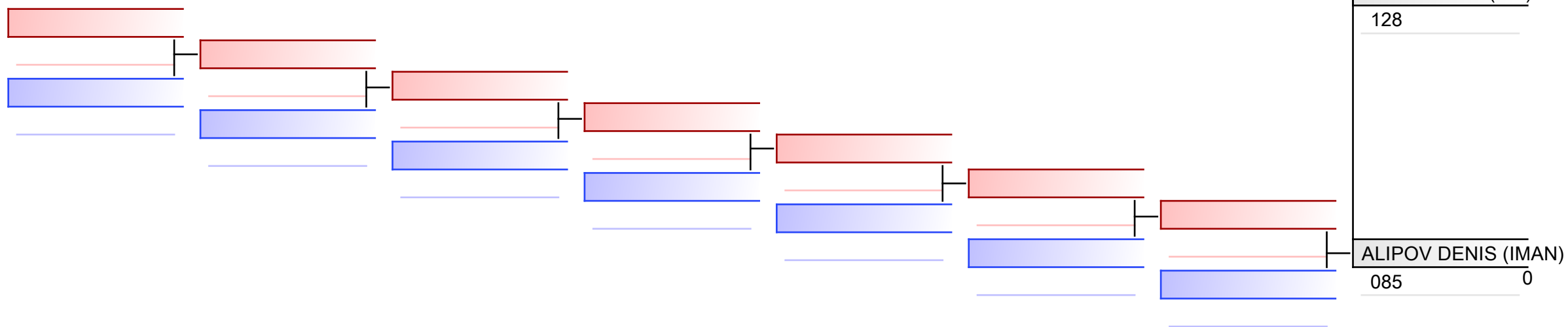

Referees:							
-----------	--	--	--	--	--	--	--

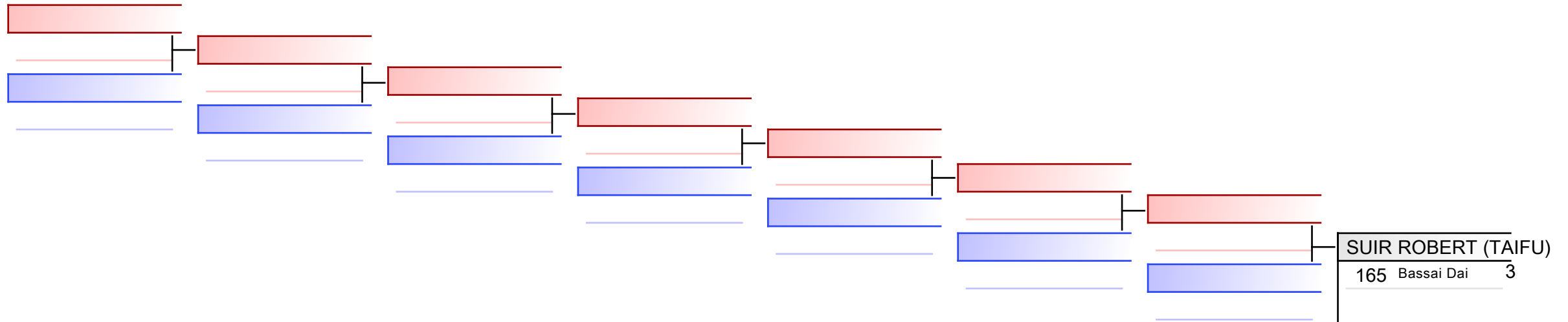

REPECHAGE: (1)

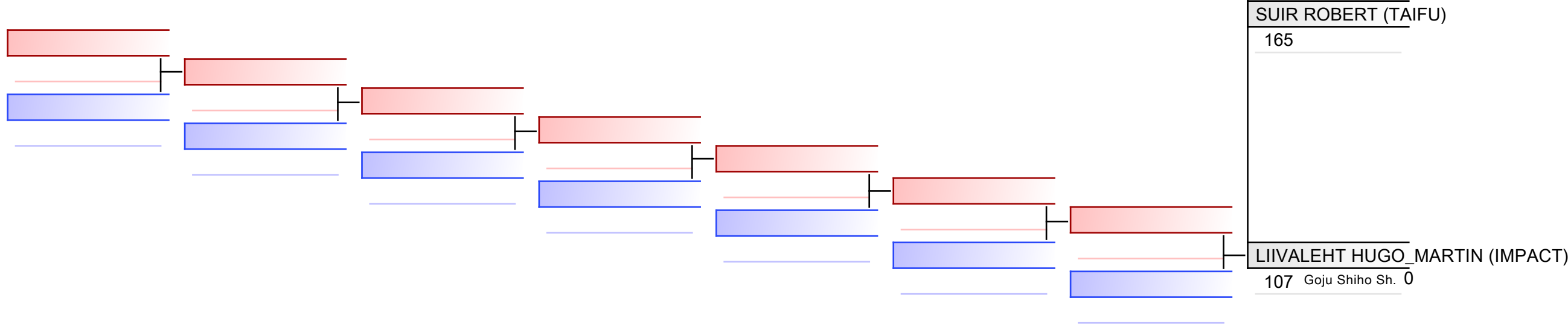

Referees:							
-----------	--	--	--	--	--	--	--