

F U10 +30 kg

Budo Cup 2022

Tatami
3 12:35

Pool
1

(c)sportdata GmbH & Co KG 2000-2022(2022-05-15 00:22) -WKF Approved- v 9.8.7 build 3 (2020-09-25) License: Estonian Karate Federation (expire 2022-11-29)

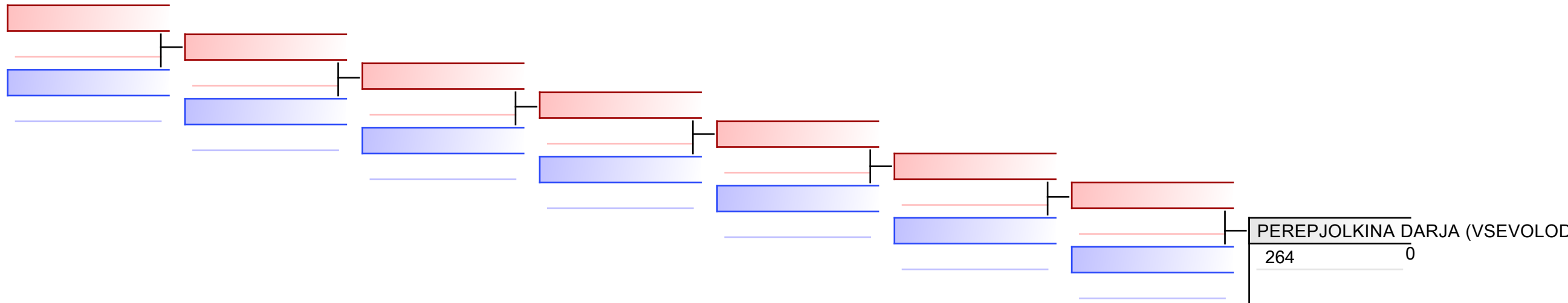

REPECHAGE: (1)

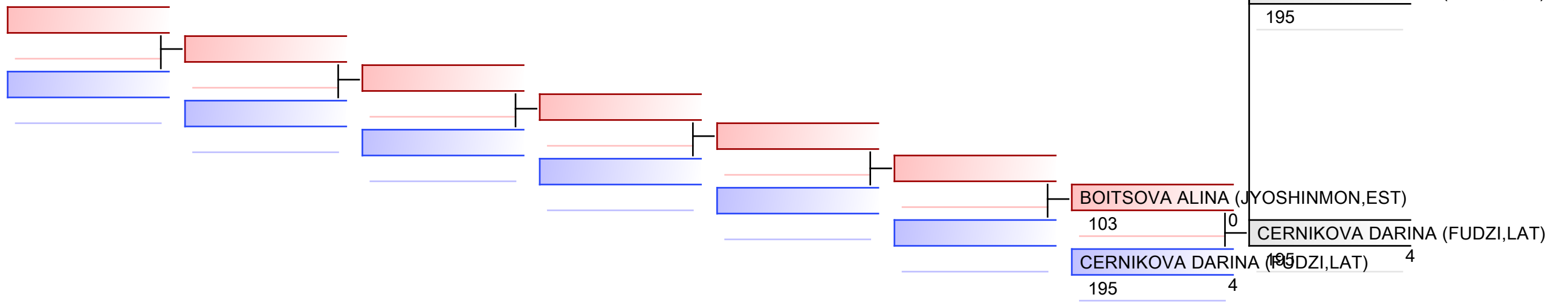

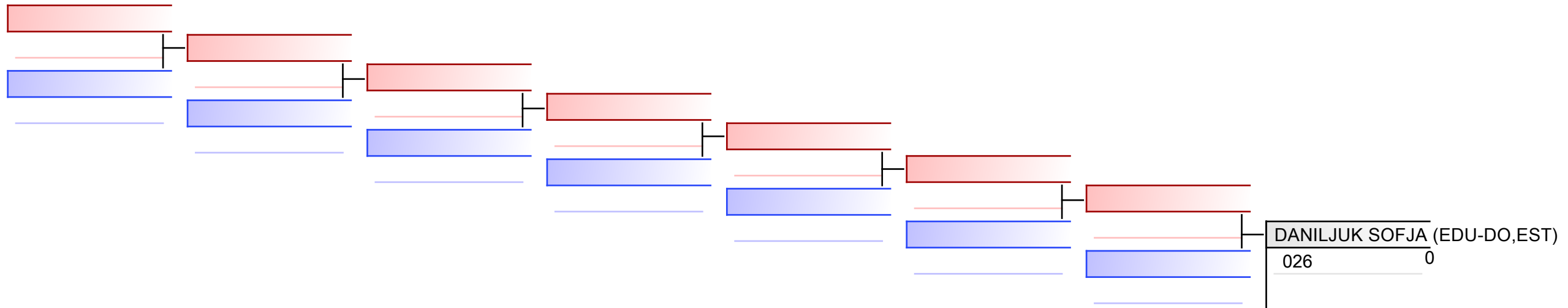

REPECHAGE: (1)

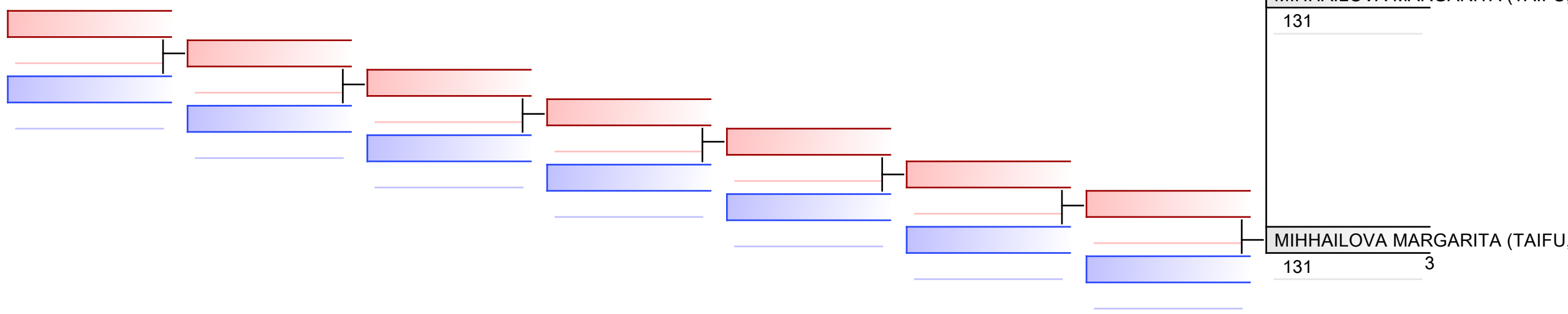

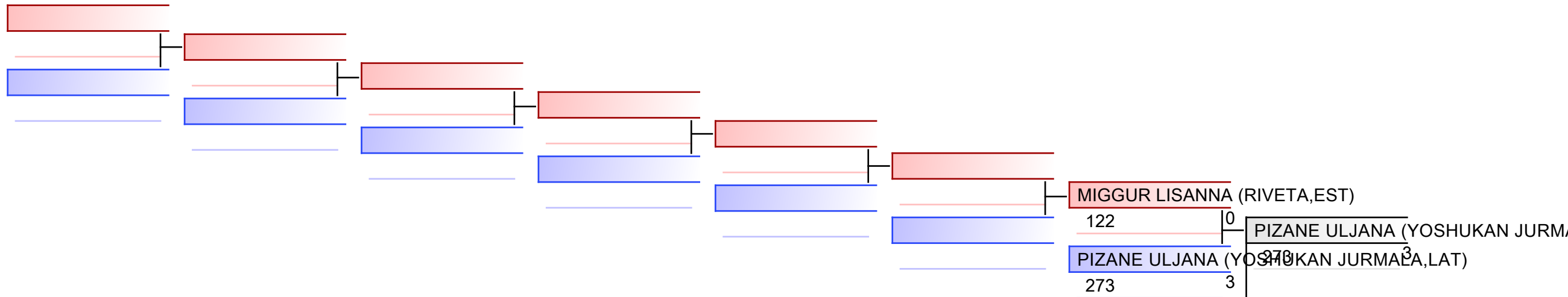

REPECHAGE: (1)

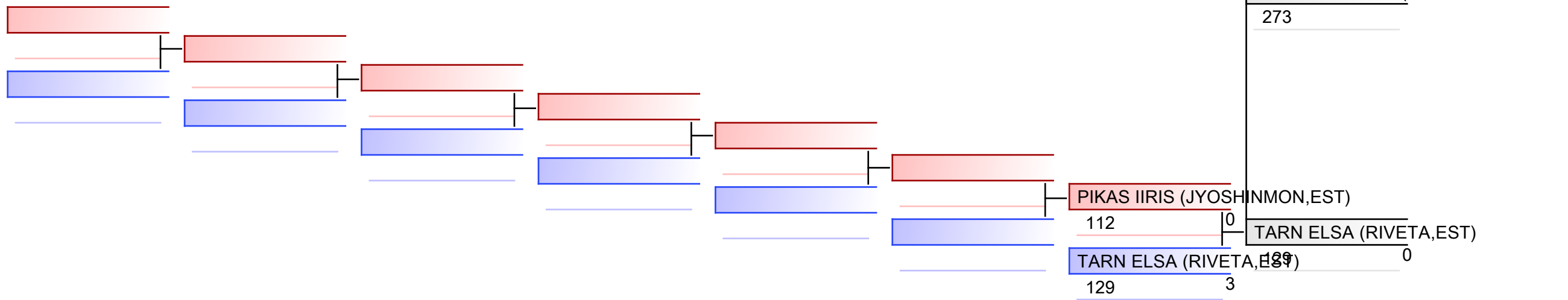

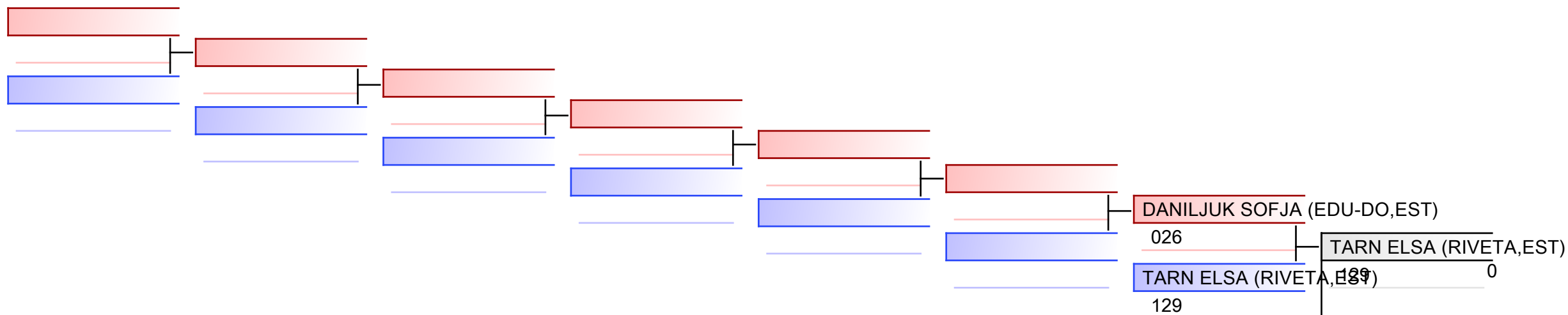

REPECHAGE: (1)

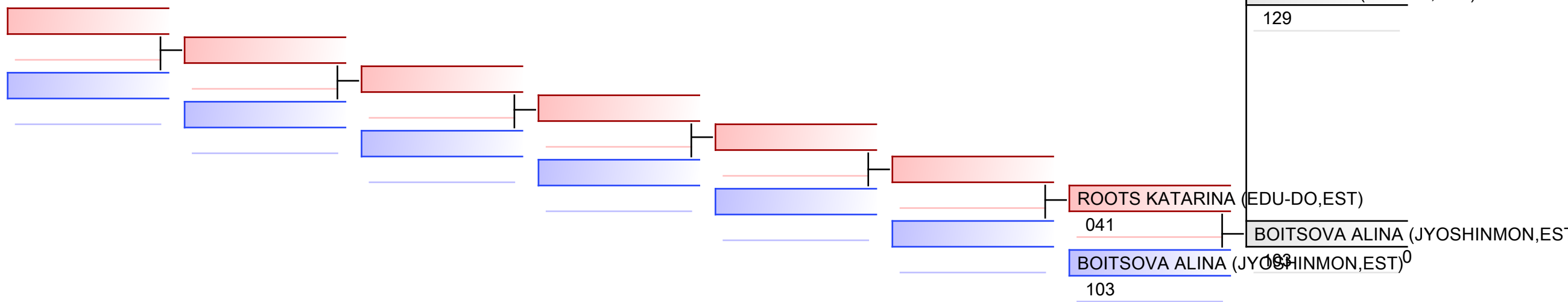

F U12 +40 kg

Budo Cup 2022

Tatami
1 12:05

Pool
1

(c)sportdata GmbH & Co KG 2000-2022(2022-05-15 00:22) -WKF Approved- v 9.8.7 build 3 (2020-09-25) License: Estonian Karate Federation (expire 2022-11-29)

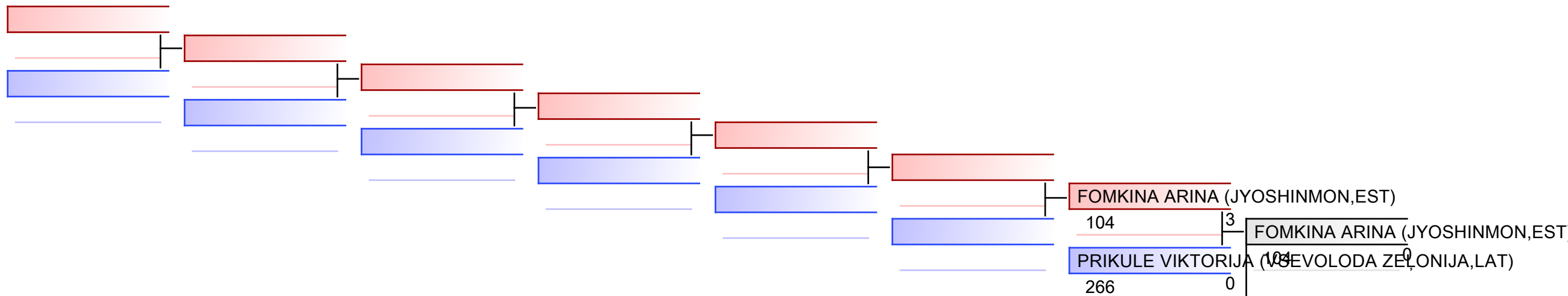

REPECHAGE: (1)

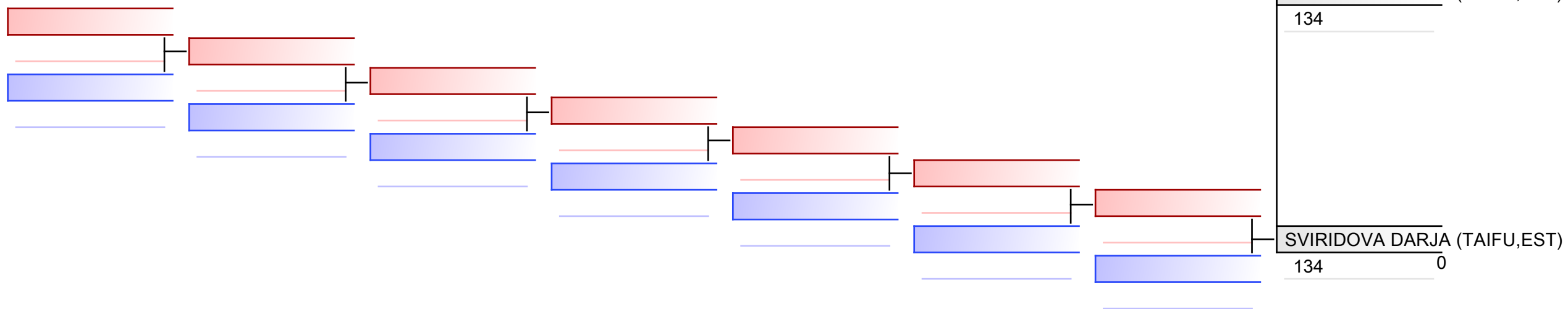

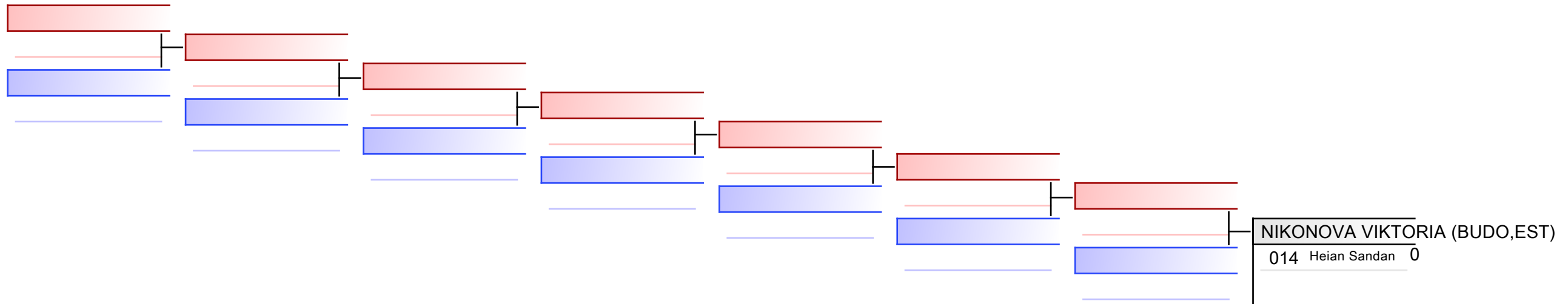

REPECHAGE: (1)

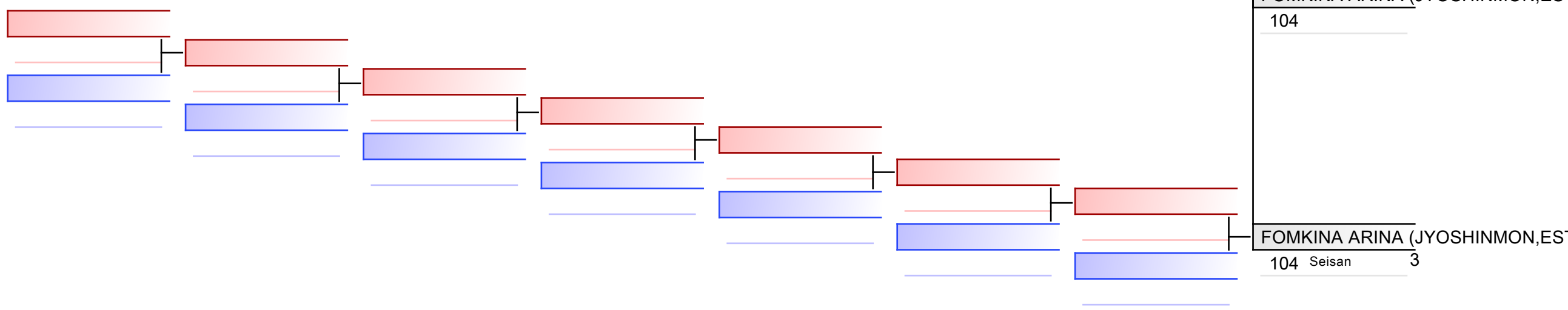

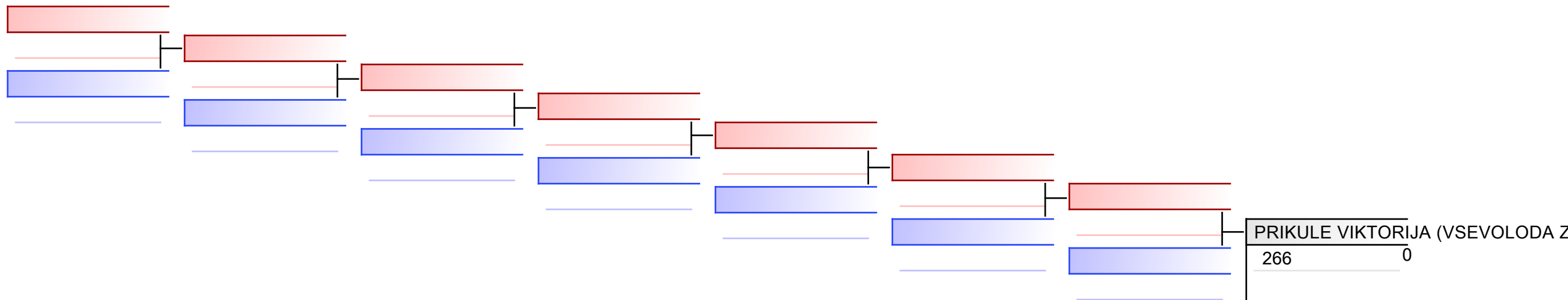

REPECHAGE: (1)

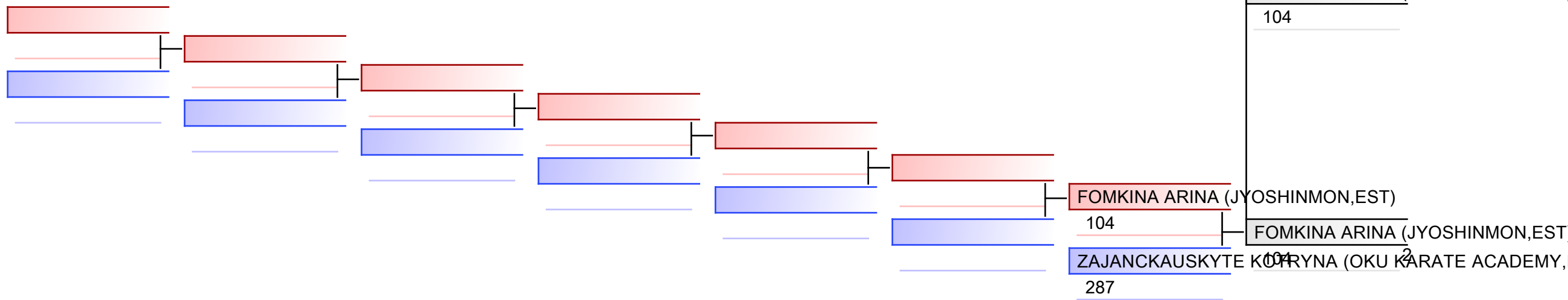

F U14 +47 kg

Budo Cup 2022

Tatami
2 14:10

Pool
1

(c)sportdata GmbH & Co KG 2000-2022(2022-05-15 00:22) -WKF Approved- v 9.8.7 build 3 (2020-09-25) License: Estonian Karate Federation (expire 2022-11-29)

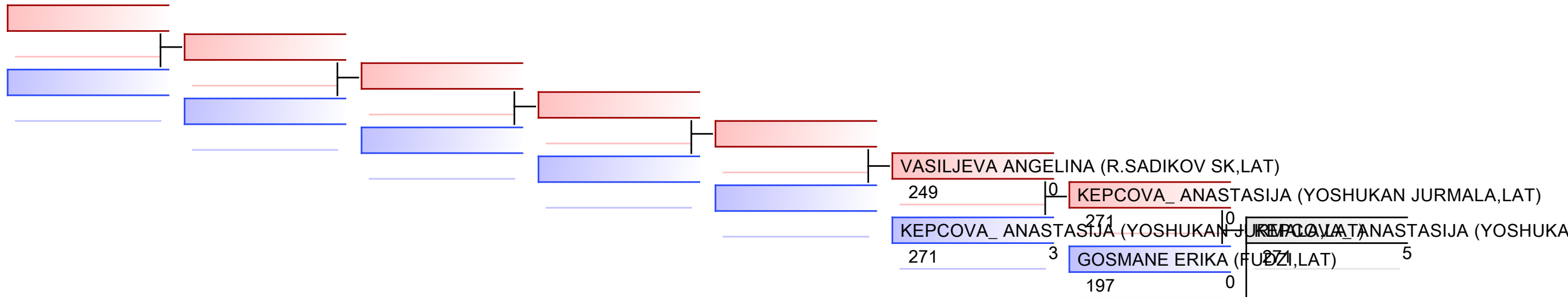

REPECHAGE: (1)

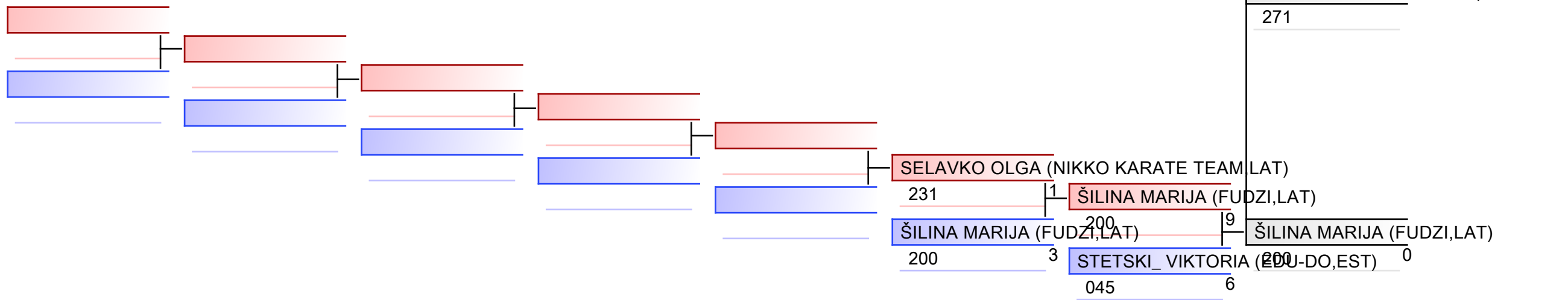

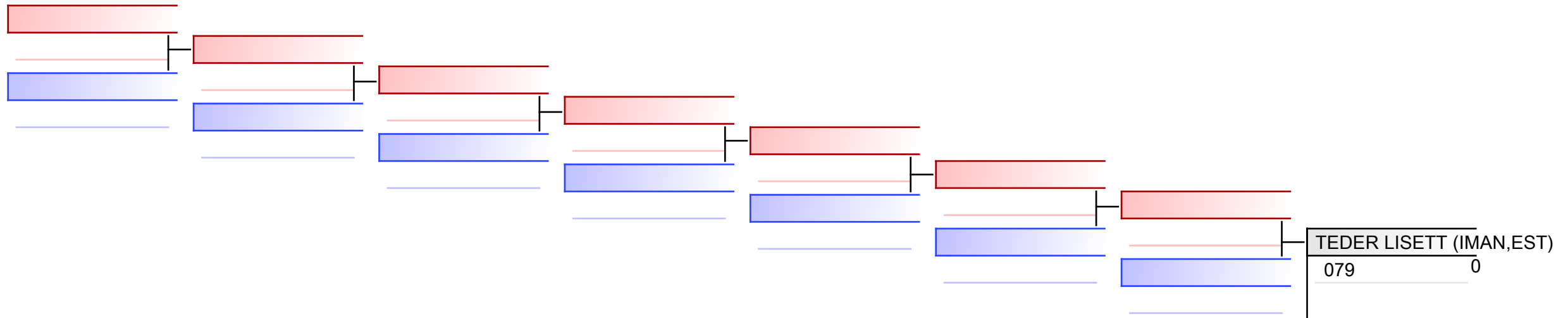

REPECHAGE: (1)

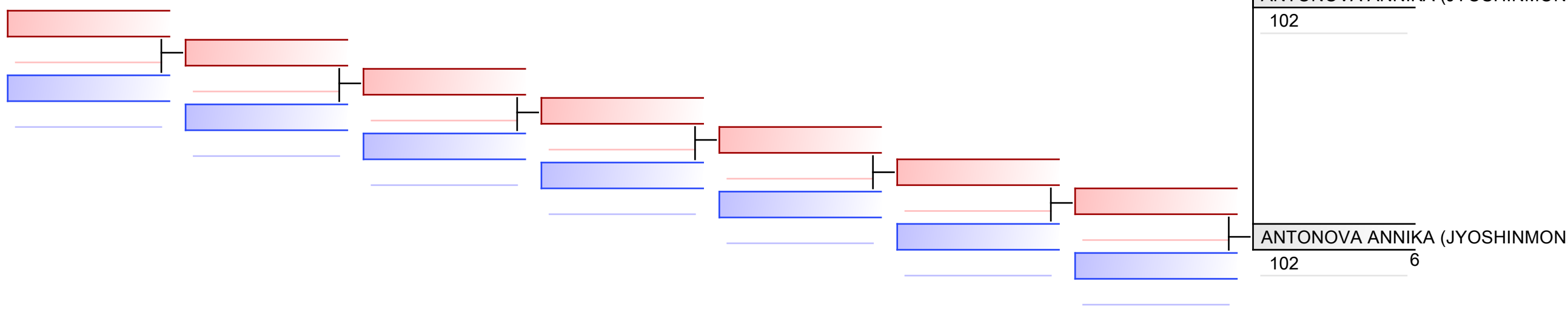

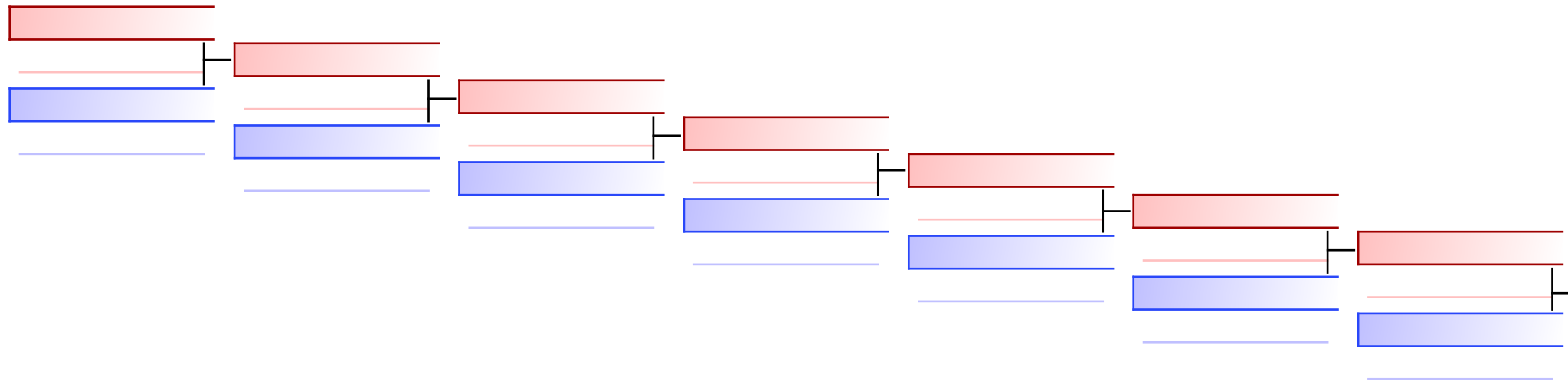

TŠERNETSOVA LINDA (JYOSHINMON
113 6

REPECHAGE: (1)

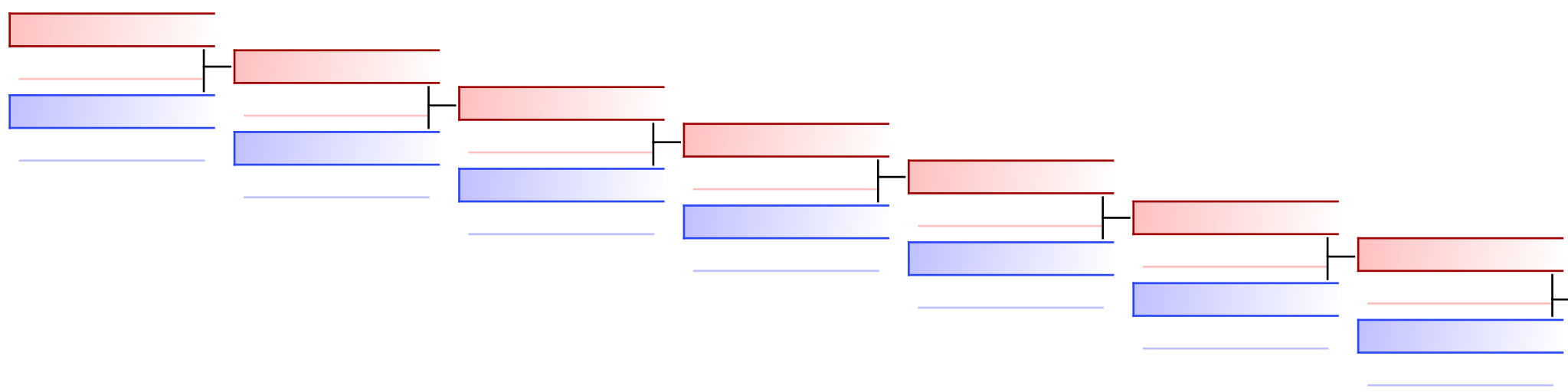

TŠERNETSOVA LINDA (JYOSHINMON
113

MEDNE VIKTORIJA (BOLDERAJAS, L
184 4

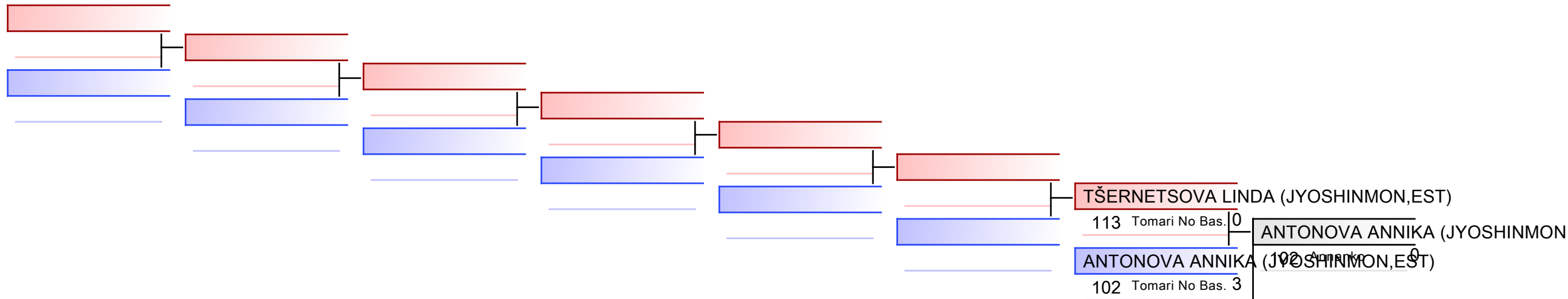

REPECHAGE: (1)

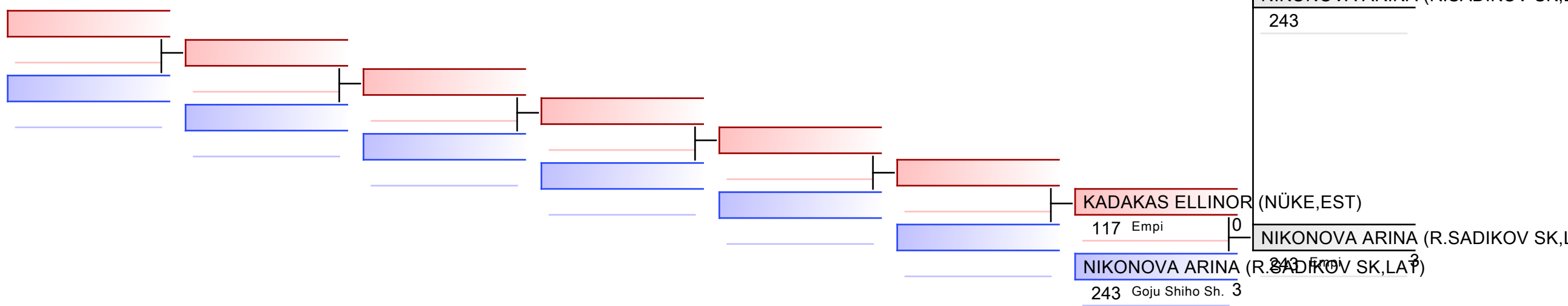

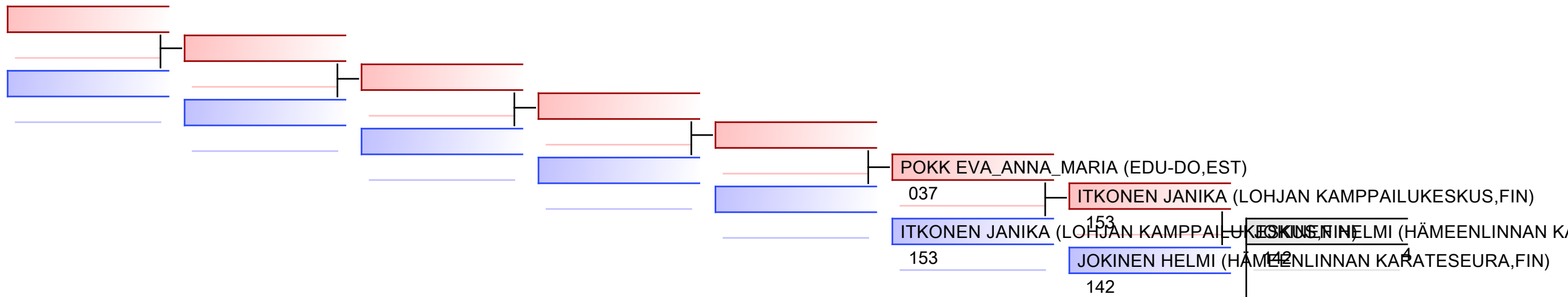

REPECHAGE: (1)

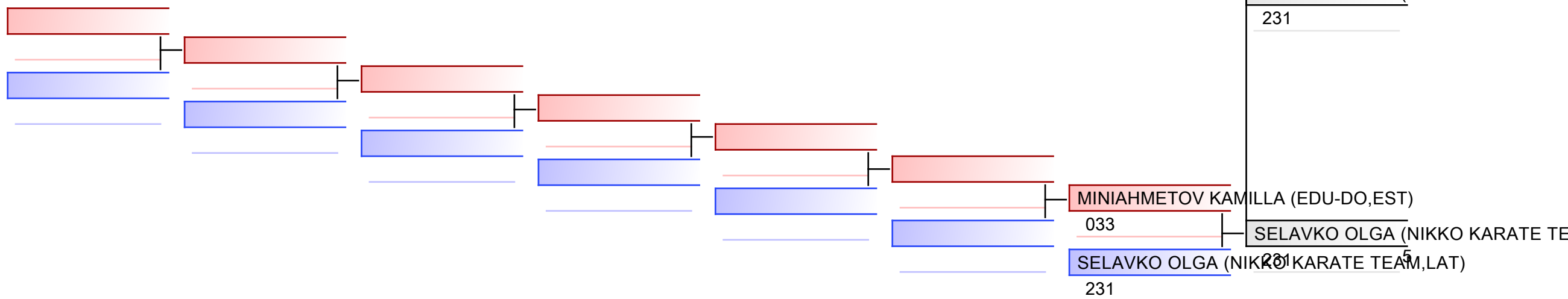

F U16 +54 kg

Budo Cup 2022

Tatami
3 16:50

Pool
1

(c)sportdata GmbH & Co KG 2000-2022(2022-05-15 00:22) -WKF Approved- v 9.8.7 build 3 (2020-09-25) License: Estonian Karate Federation (expire 2022-11-29)

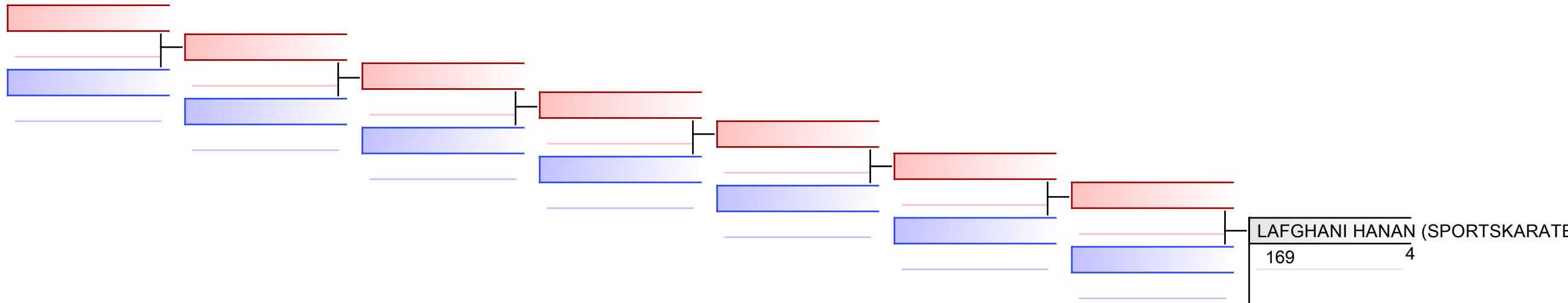

REPECHAGE: (1)

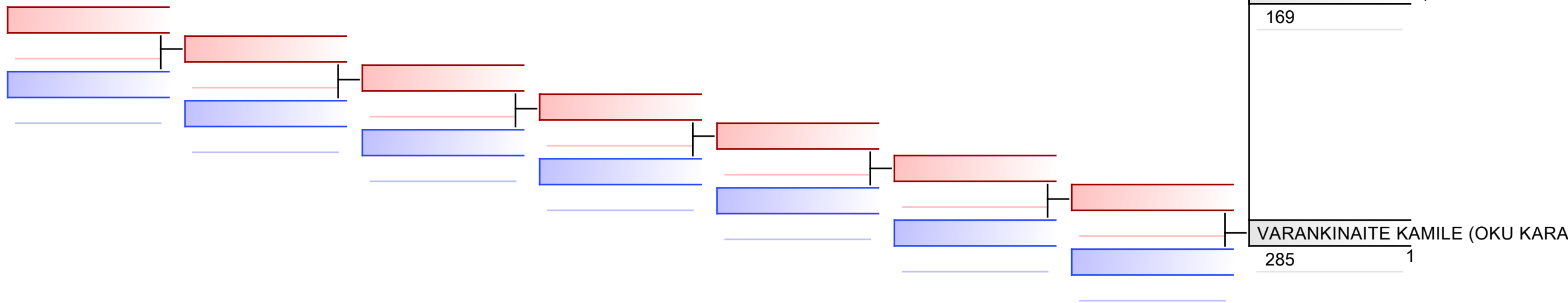

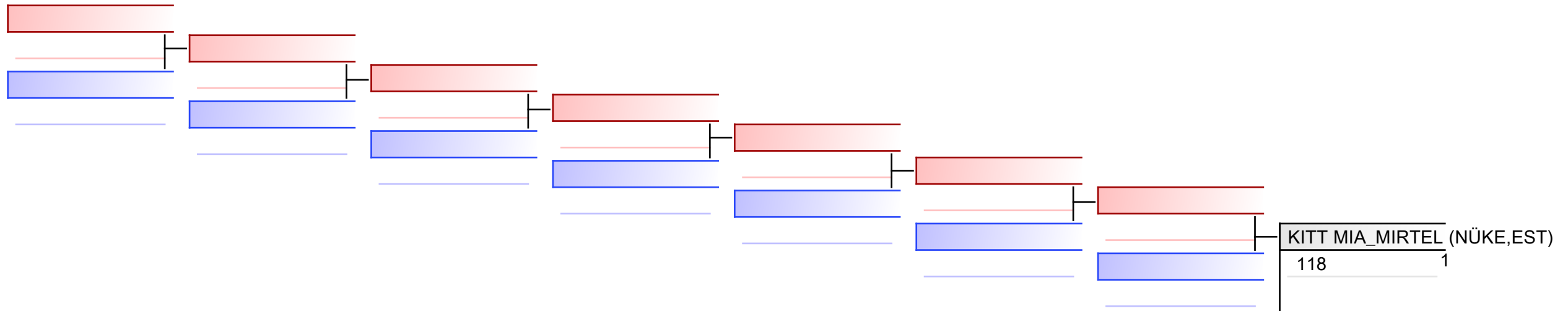

REPECHAGE: (1)

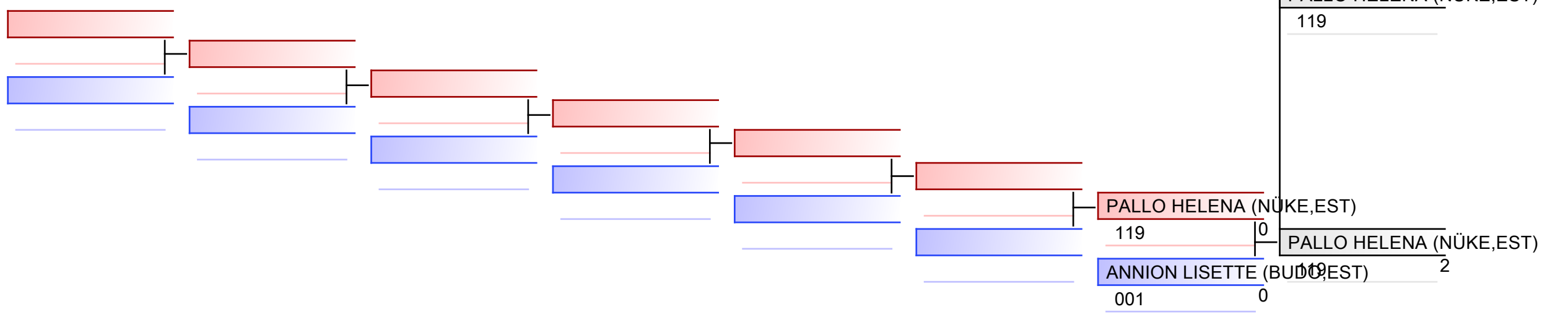

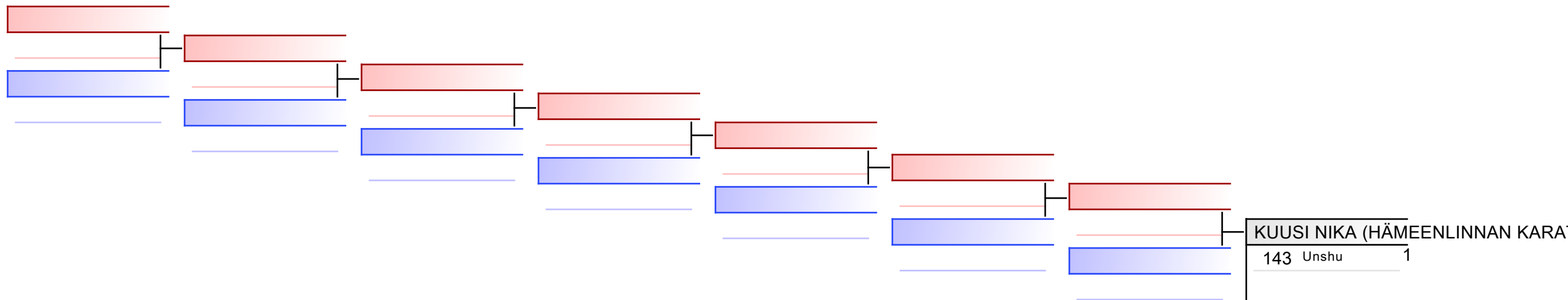

REPECHAGE: (1)

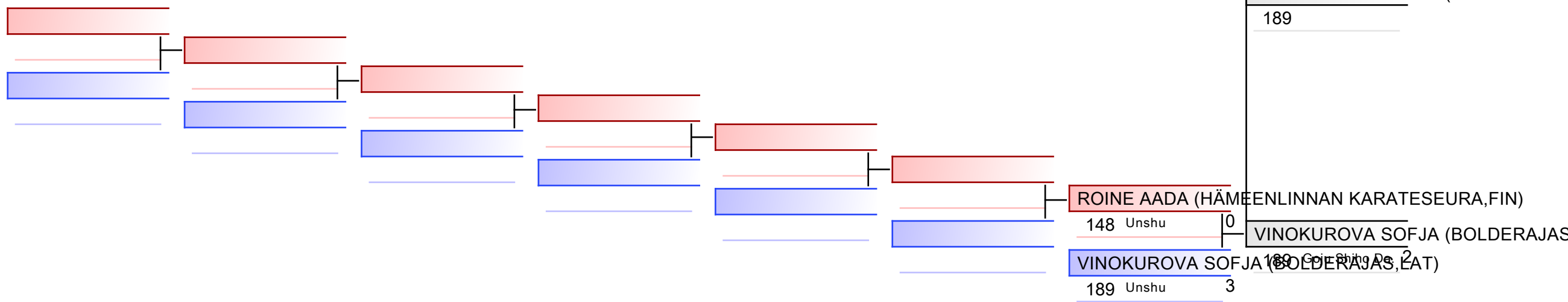

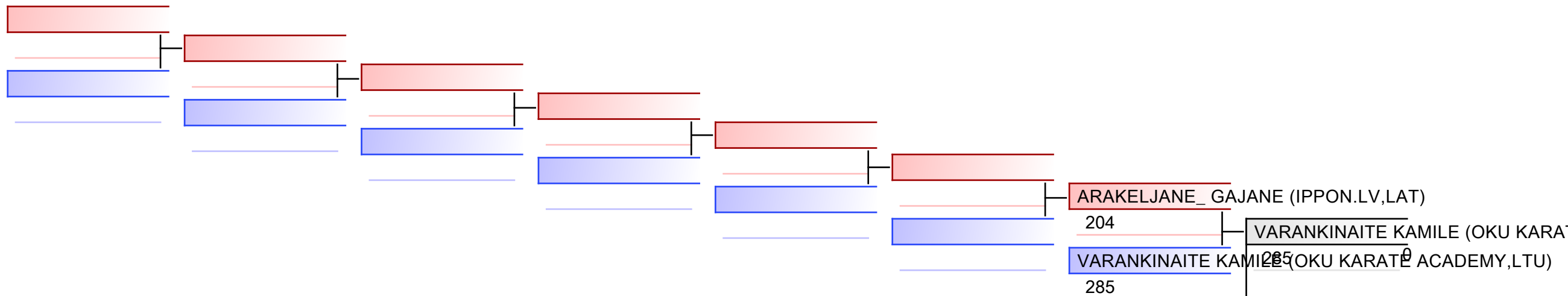

REPECHAGE: (1)

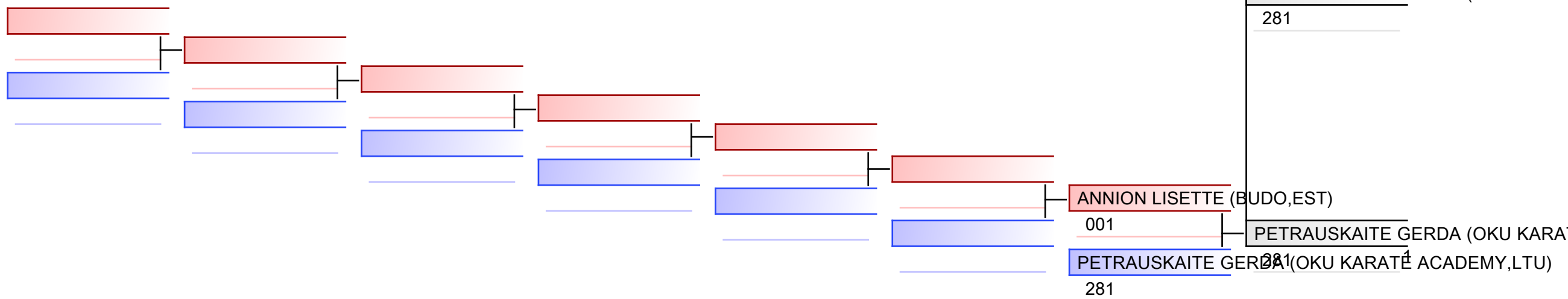

F U18 +59 kg

Budo Cup 2022

Tatami
2 18:15

Pool
1

(c)sportdata GmbH & Co KG 2000-2022(2022-05-15 00:23) -WKF Approved- v 9.8.7 build 3 (2020-09-25) License: Estonian Karate Federation (expire 2022-11-29)

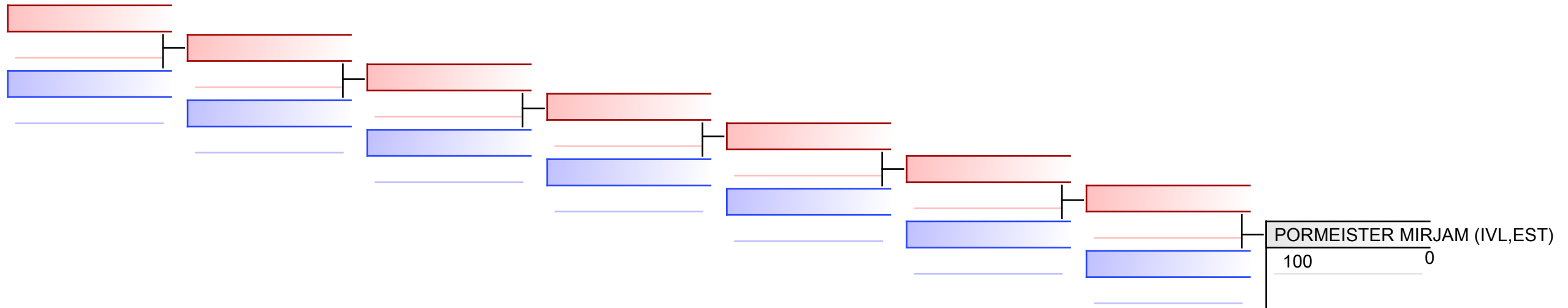

REPECHAGE: (1)

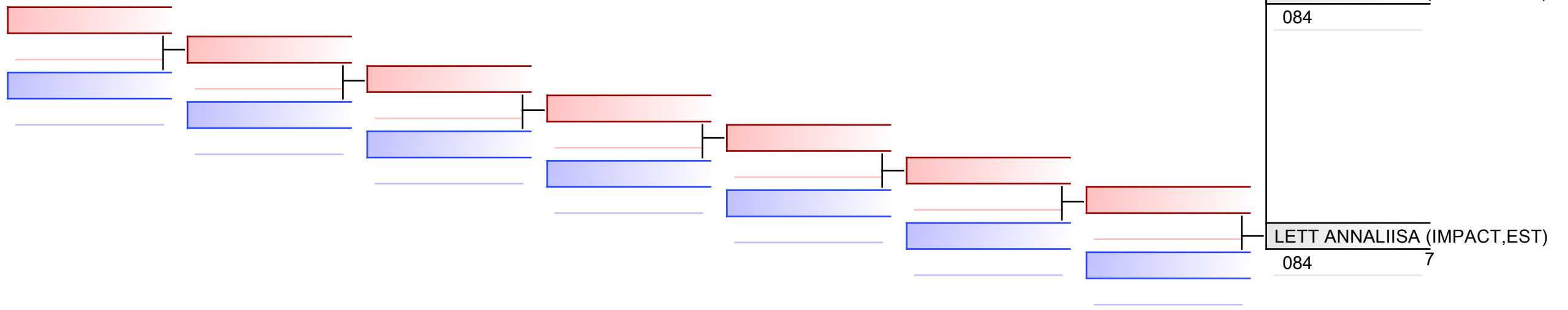

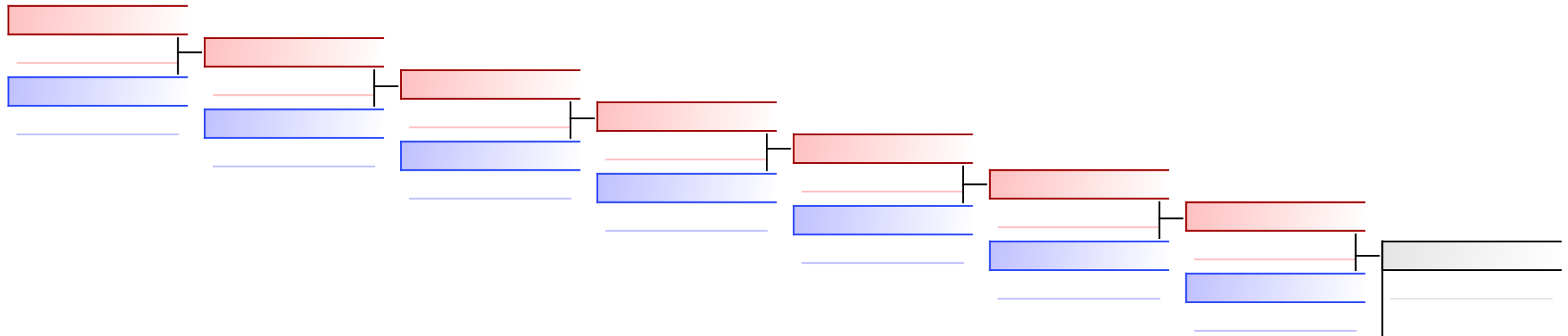

REPECHAGE: (1)

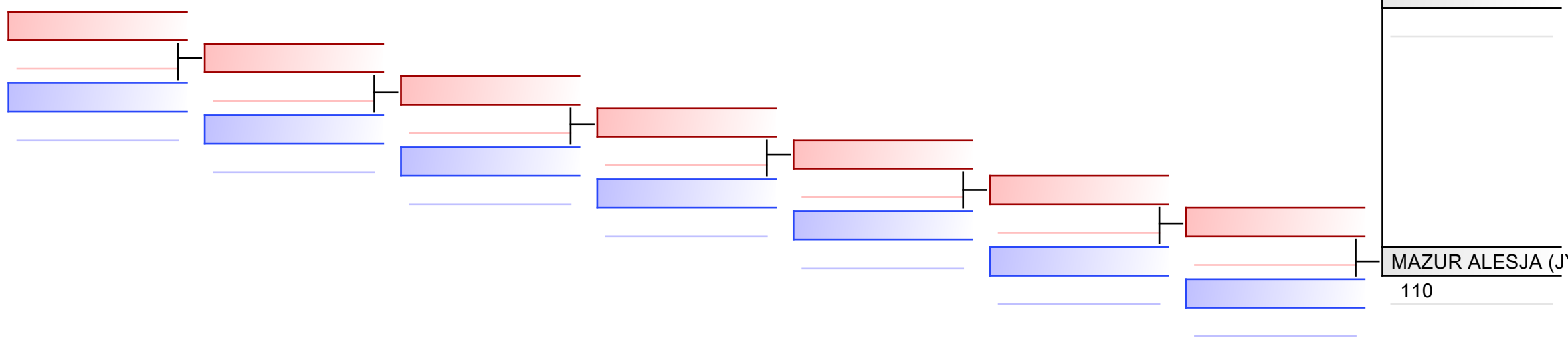

MAZUR ALESJA (JYOSHINMON, EST)

110

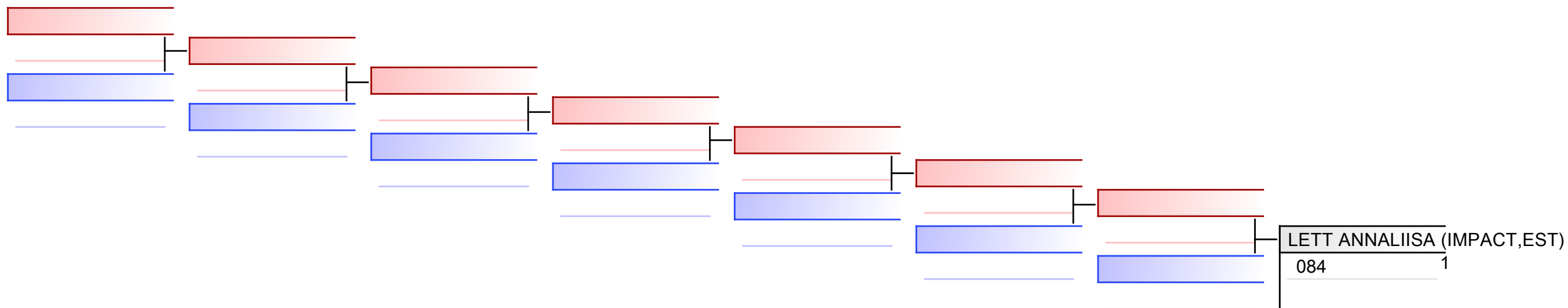

REPECHAGE: (1)

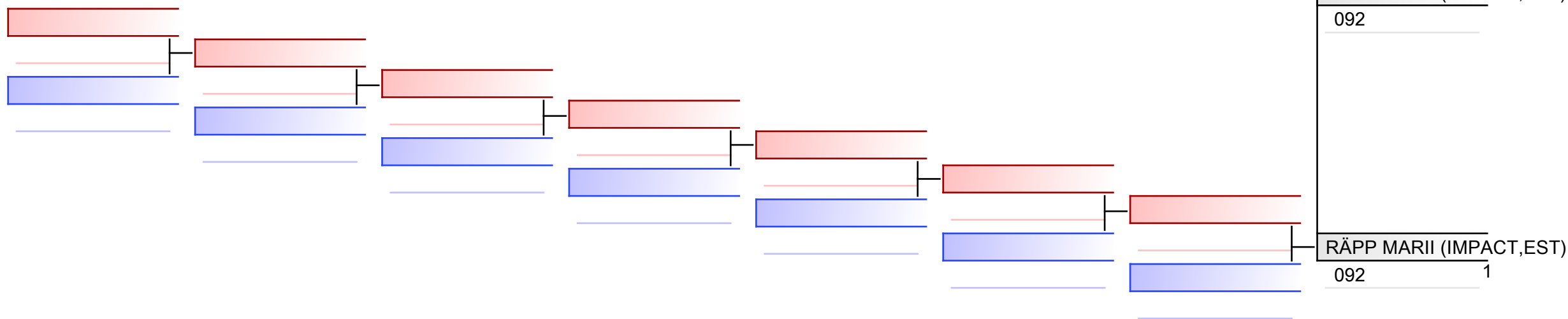

Female -61 kg

Budo Cup 2022

Tatami
3 20:25

Pool
1

(c)sportdata GmbH & Co KG 2000-2022(2022-05-15 00:23) -WKF Approved- v 9.8.7 build 3 (2020-09-25) License: Estonian Karate Federation (expire 2022-11-29)

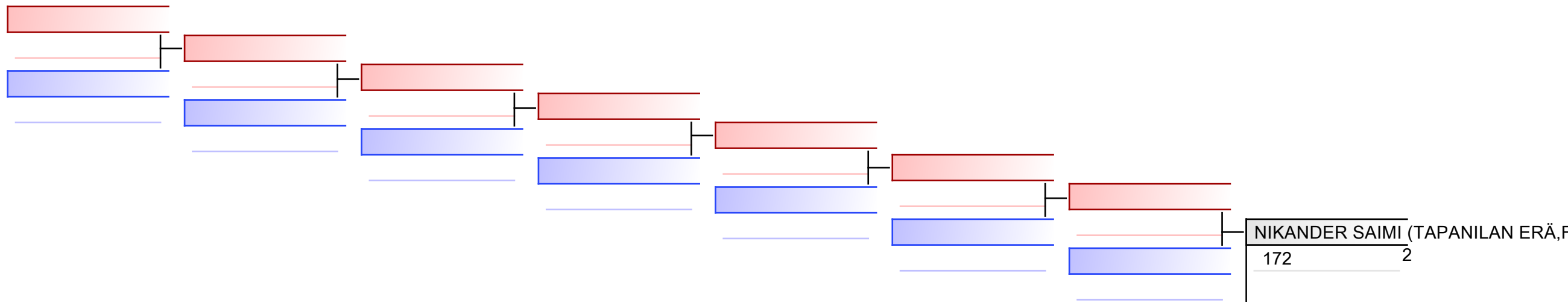

REPECHAGE: (1)

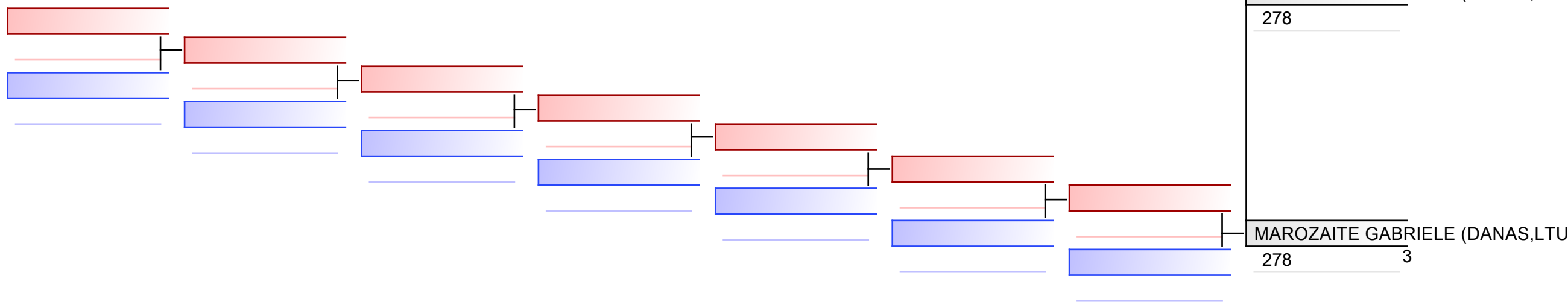

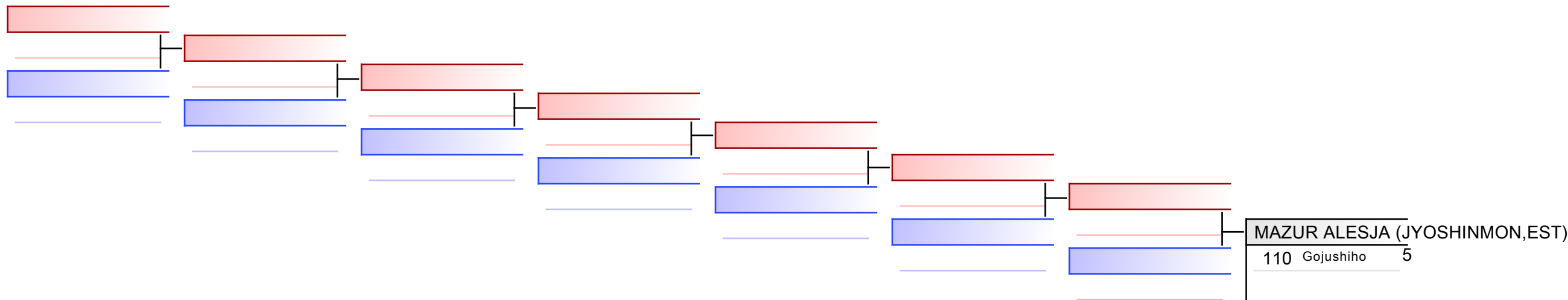

REPECHAGE: (1)

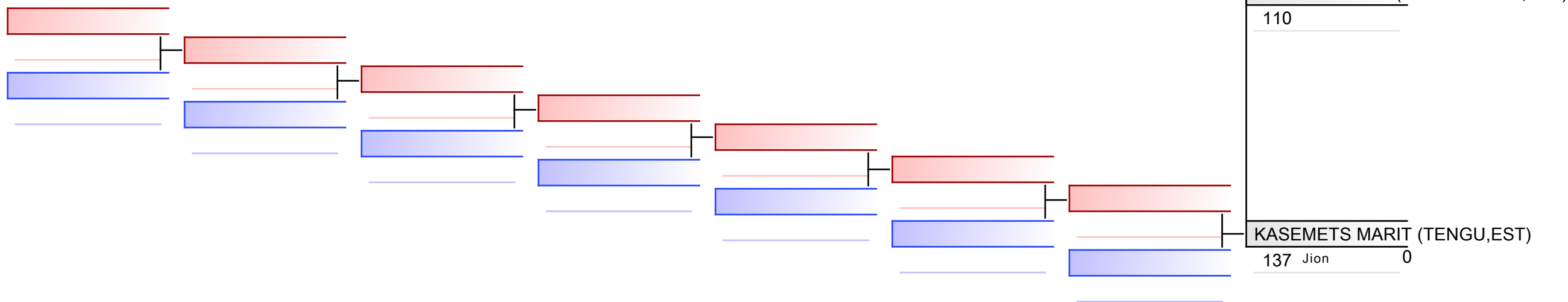

Female Open
Budo Cup 2022

Tatami 3 21:00
Pool 1

(c)sportdata GmbH & Co KG 2000-2022(2022-05-15 00:23) -WKF Approved- v 9.8.7 build 3 (2020-09-25) License: Estonian Karate Federation (expire 2022-11-29)

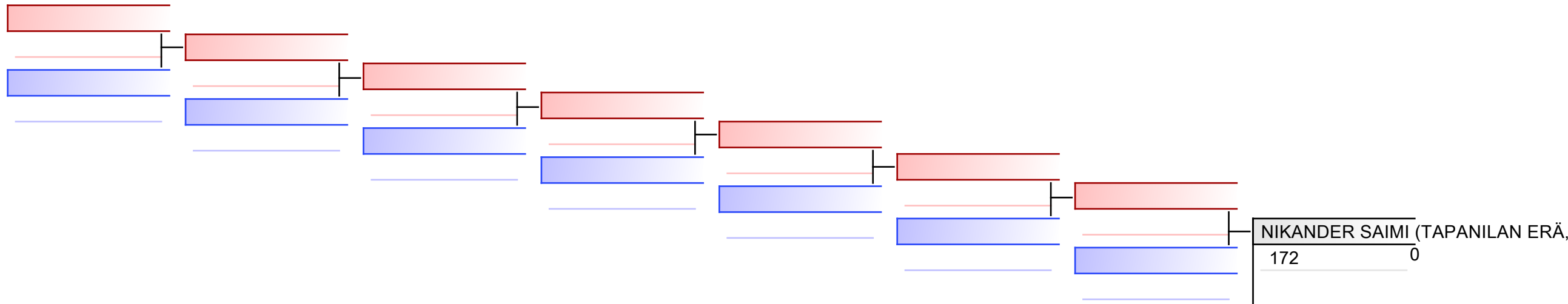

NIKANDER SAIMI (TAPANILAN ERÄ, FIN)
172 0

REPECHAGE: (1)

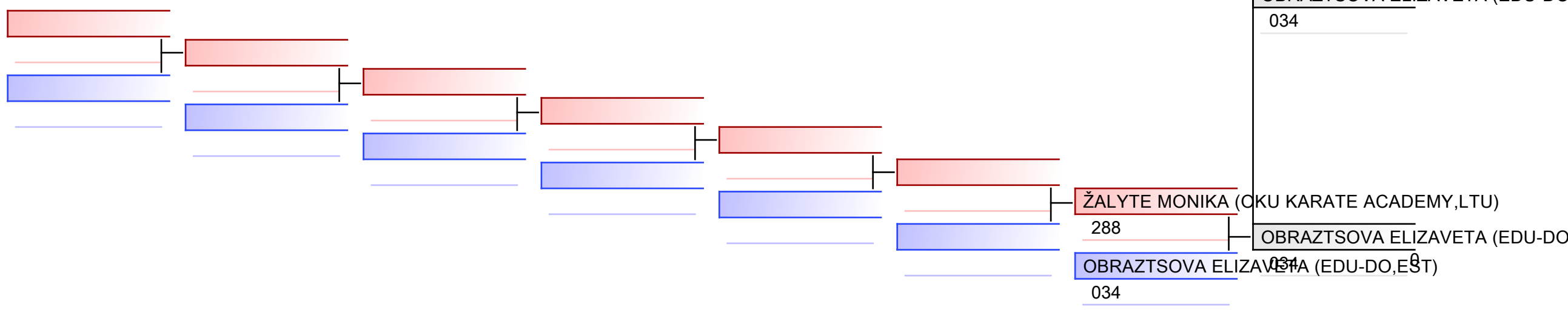

OBRAZTSOVA ELIZAVETA (EDU-DO, EST)
034

ŽALYTE MONIKA (OKU KARATE ACADEMY, LTU)
288

OBRAZTSOVA ELIZAVETA (EDU-DO, EST)
034

OBRAZTSOVA ELIZAVETA (EDU-DO, EST)
034

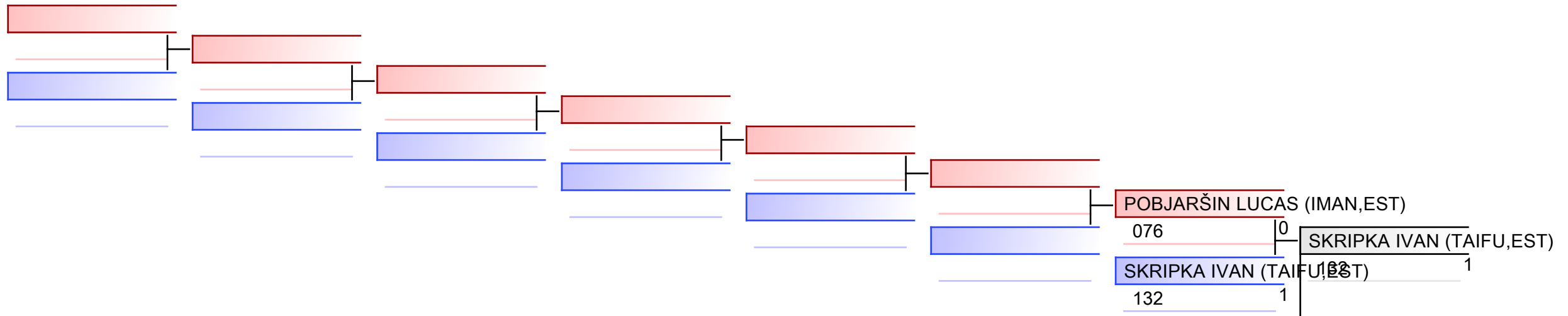

REPECHAGE: (1)

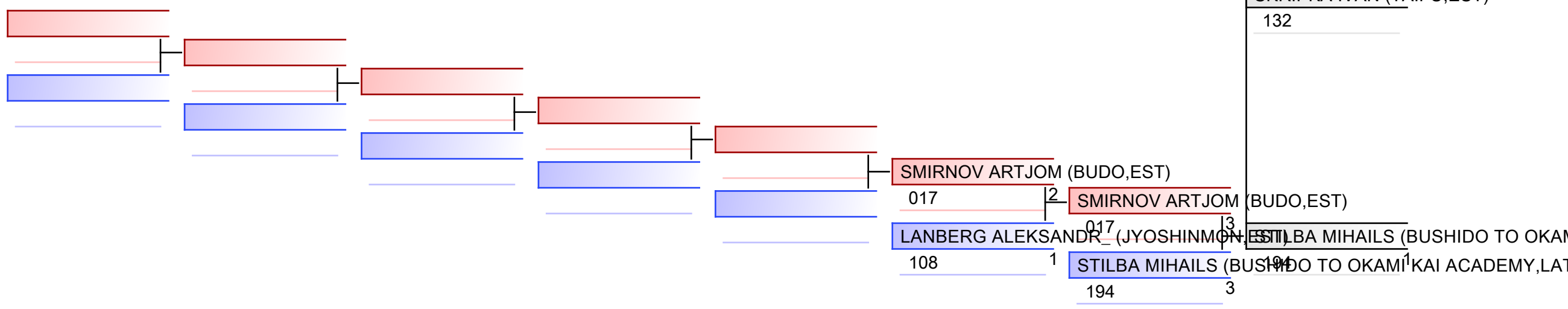

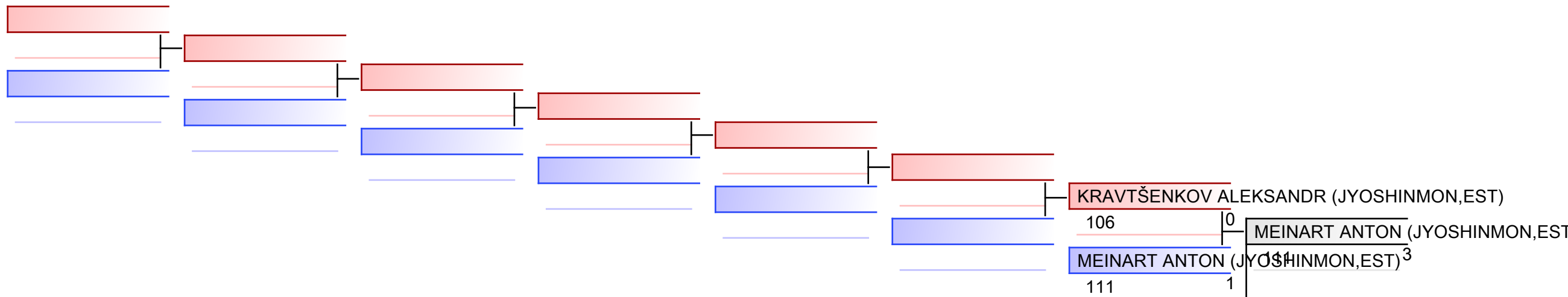

REPECHAGE: (1)

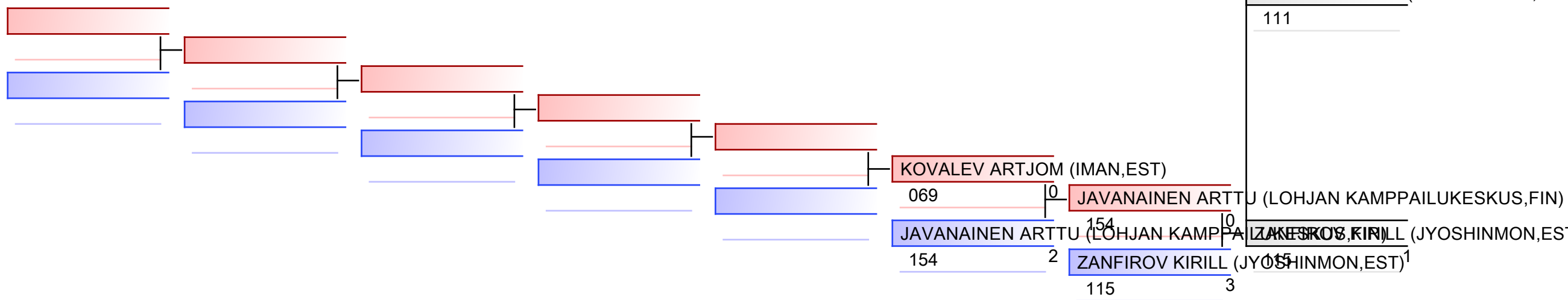

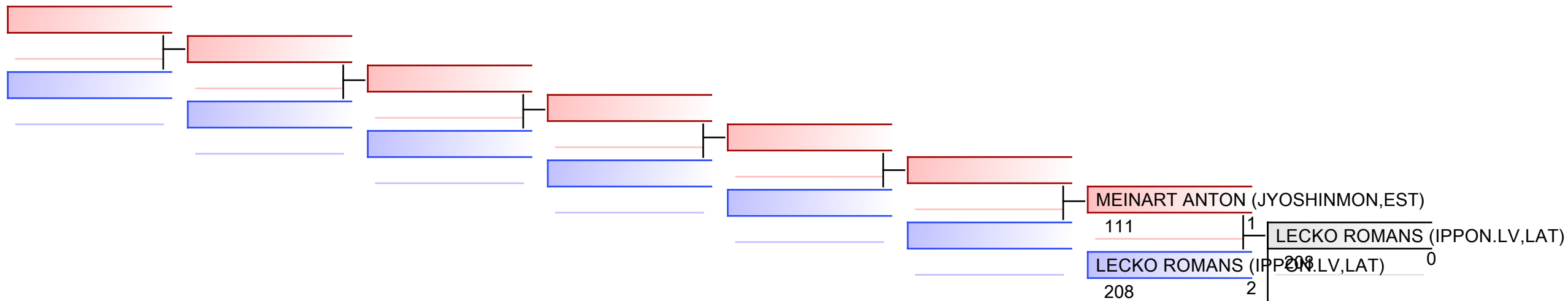

REPECHAGE: (1)

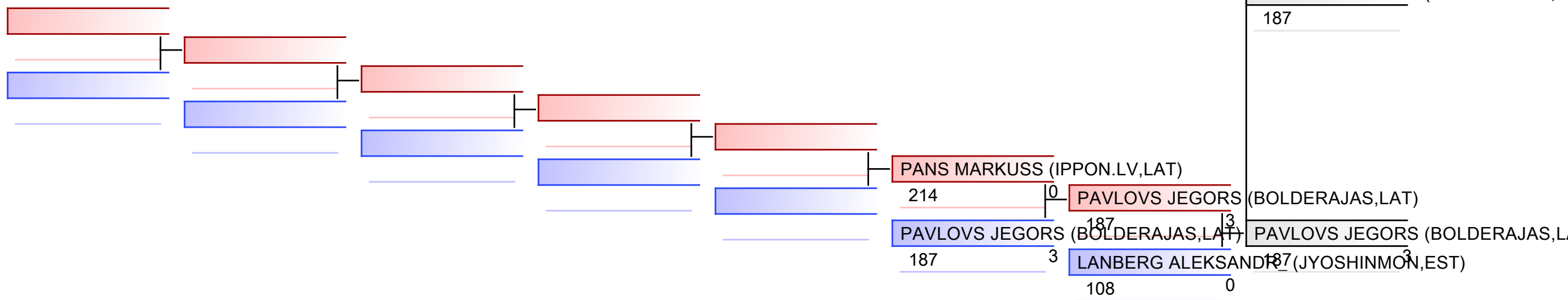

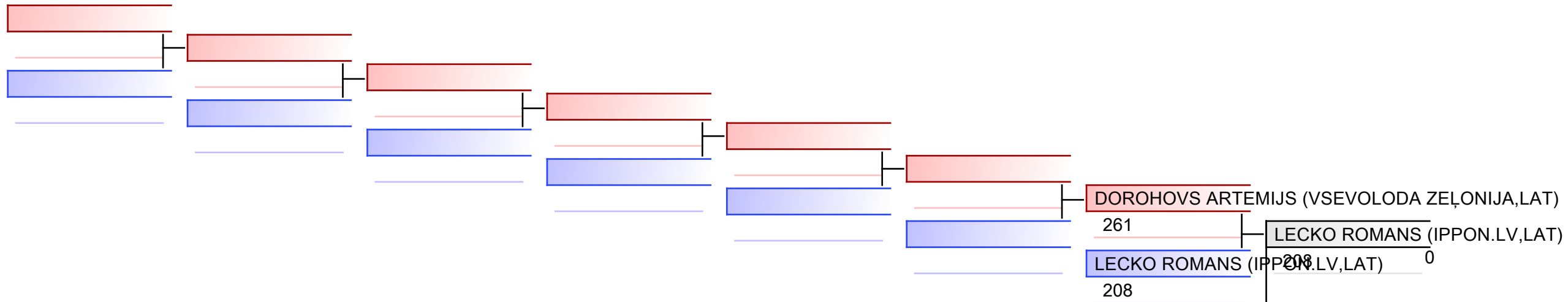

REPECHAGE: (1)

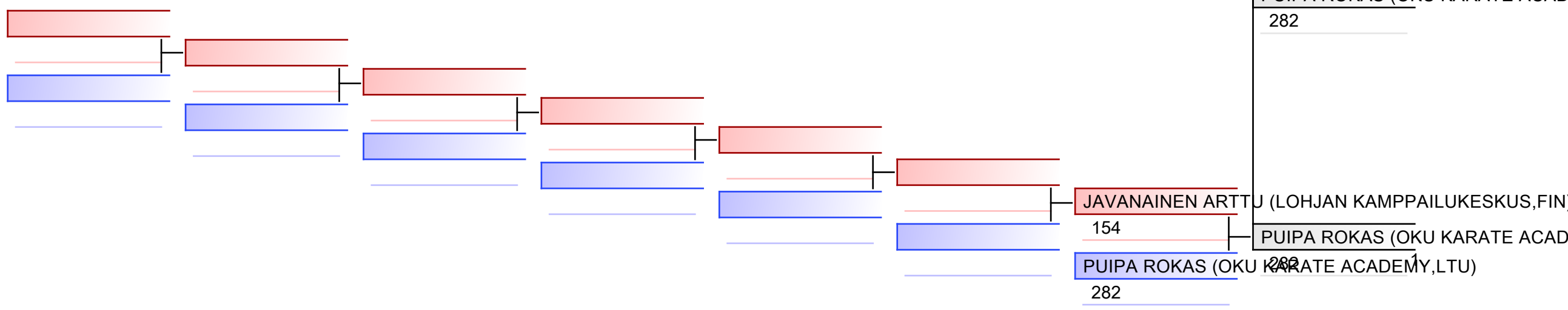

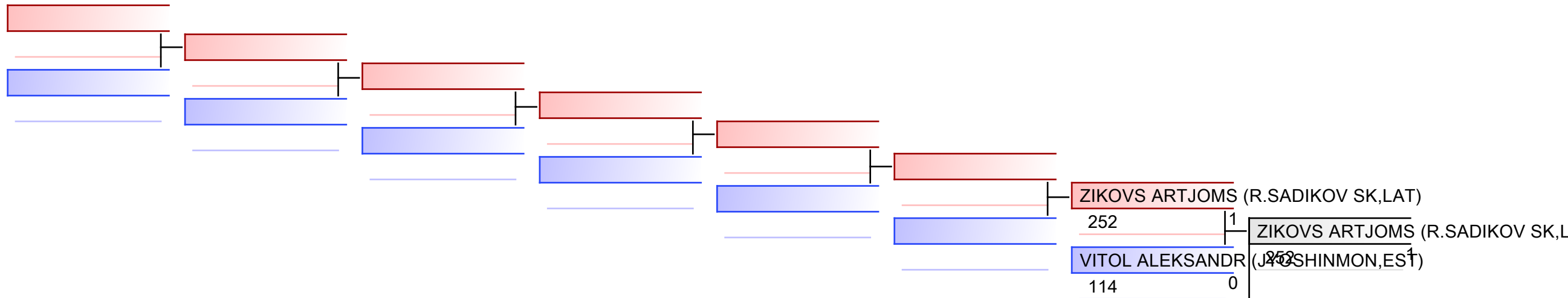

REPECHAGE: (1)

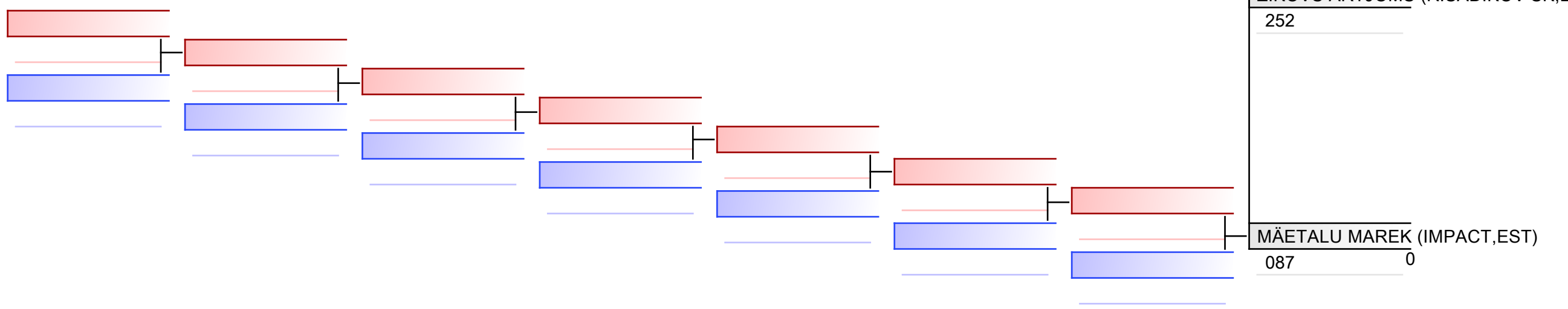

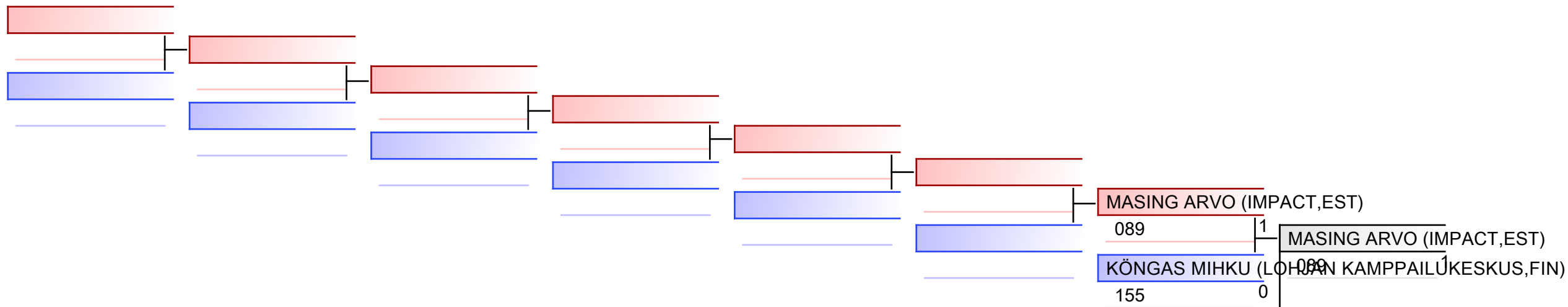

REPECHAGE: (1)

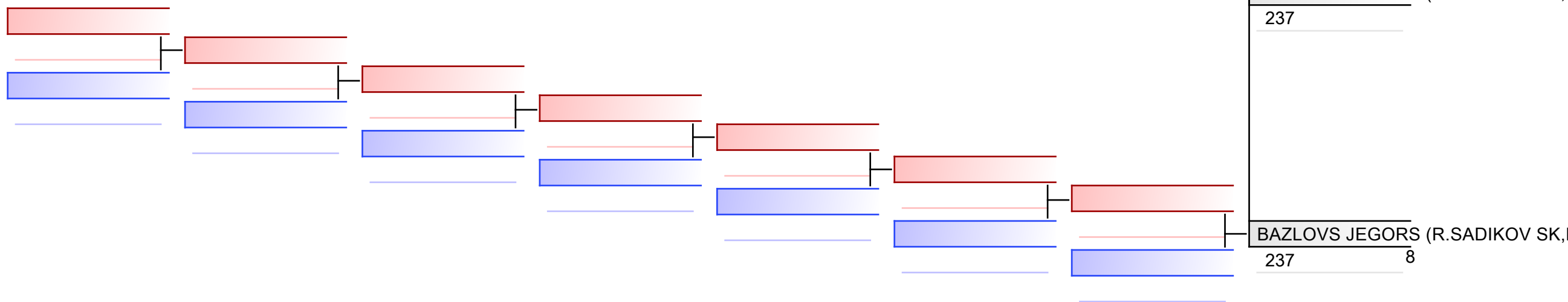

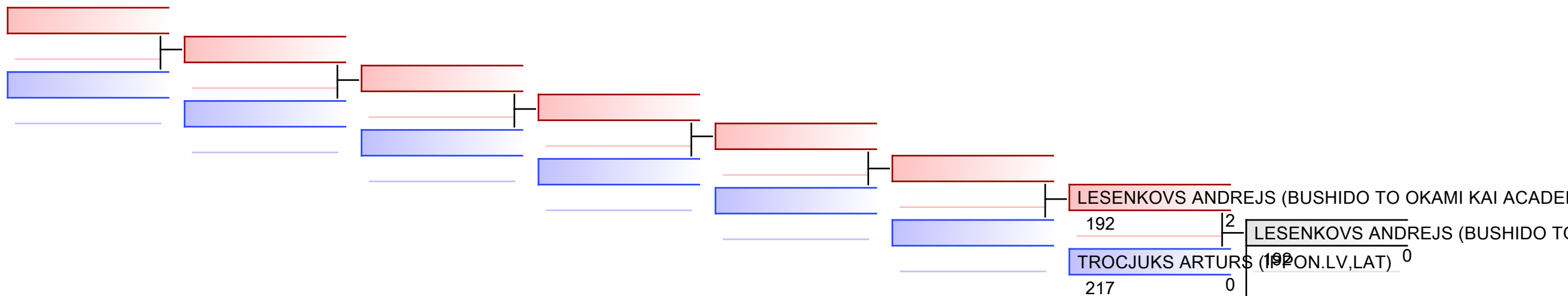

REPECHAGE: (1)

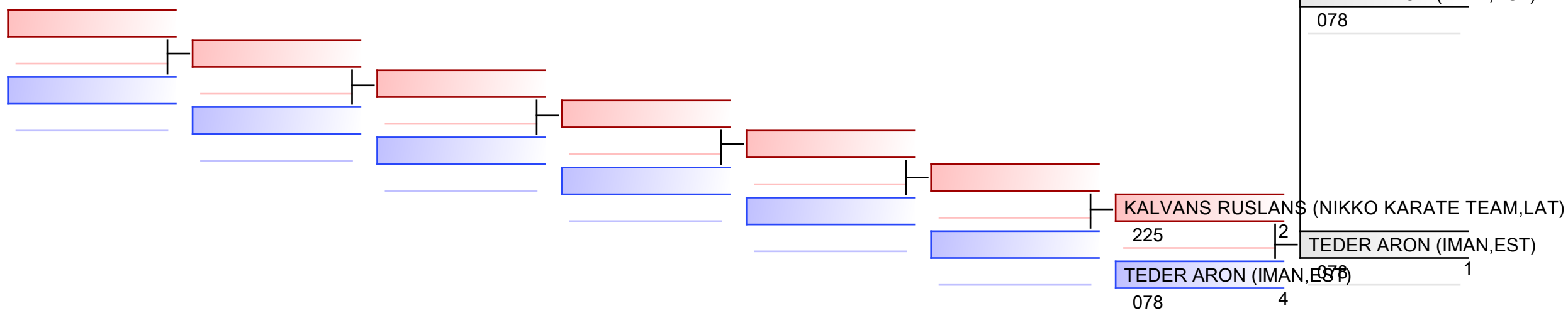

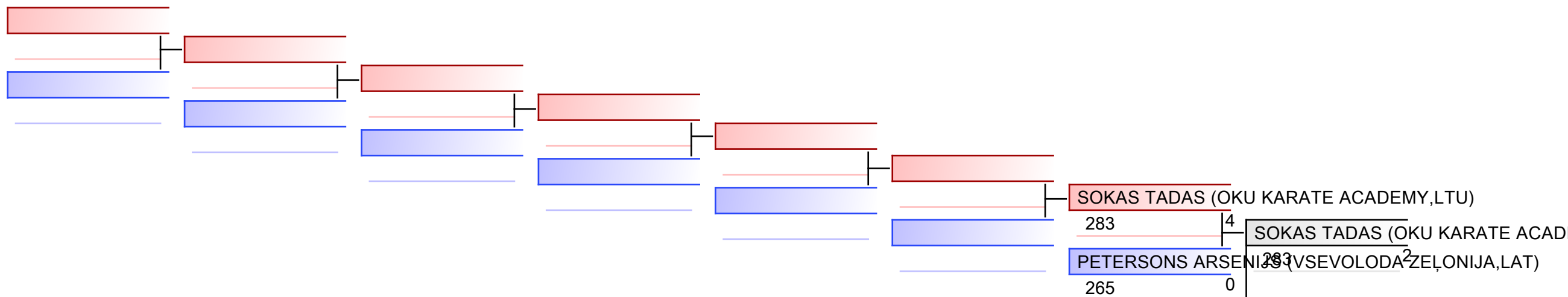

REPECHAGE: (1)

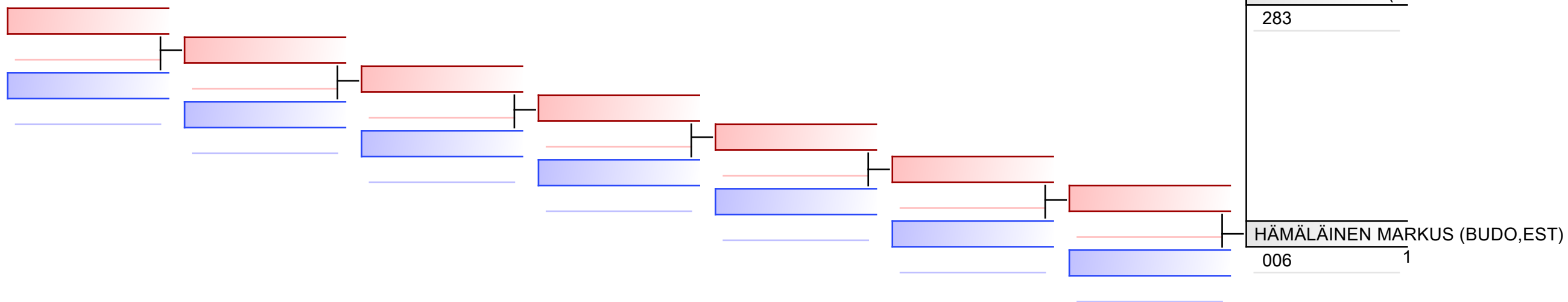

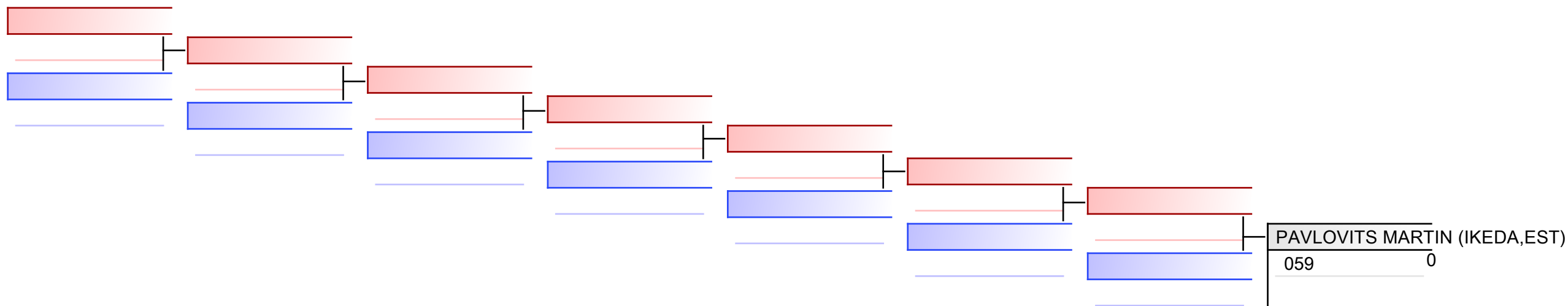

REPECHAGE: (1)

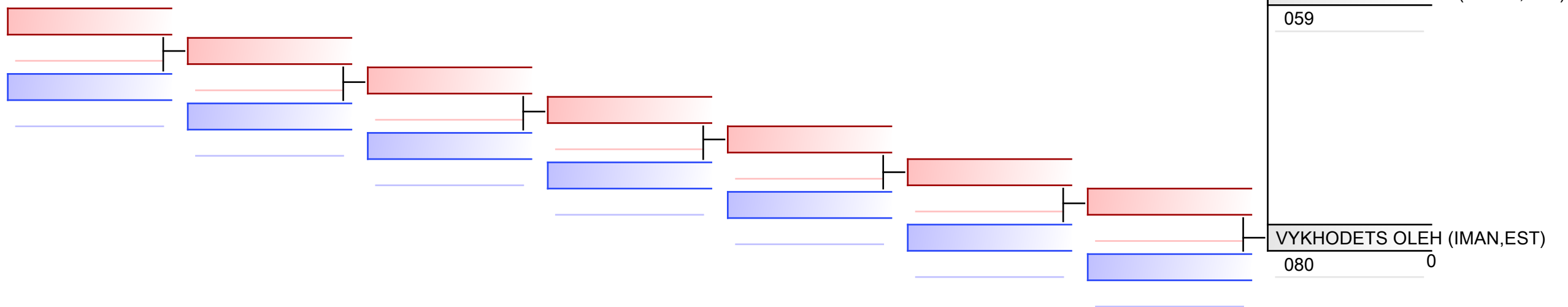

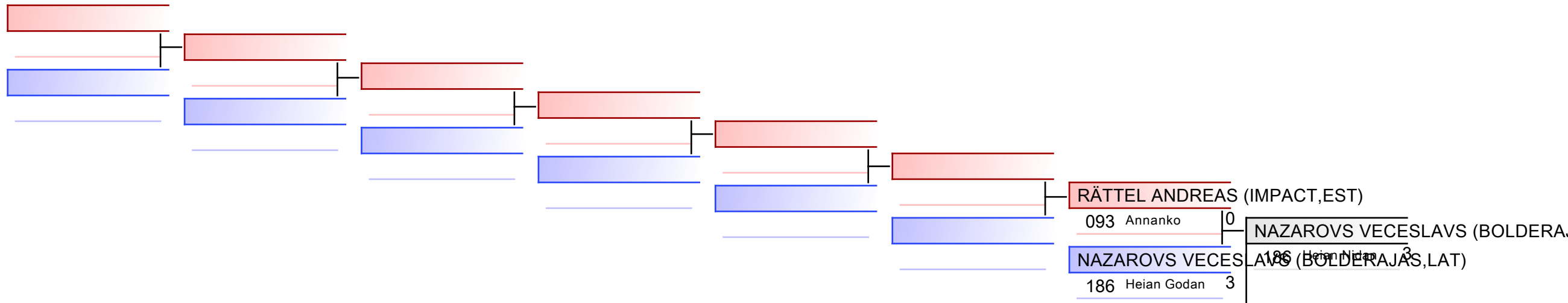

REPECHAGE: (1)

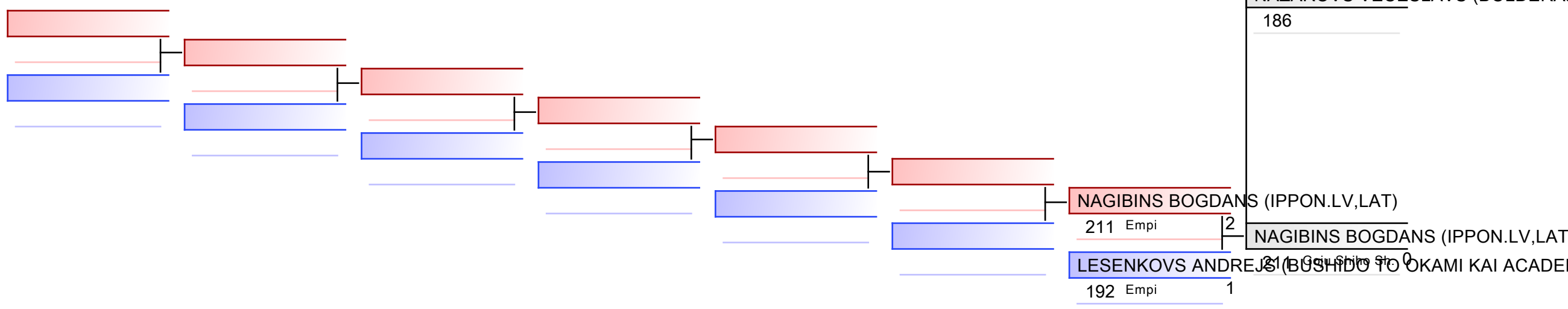

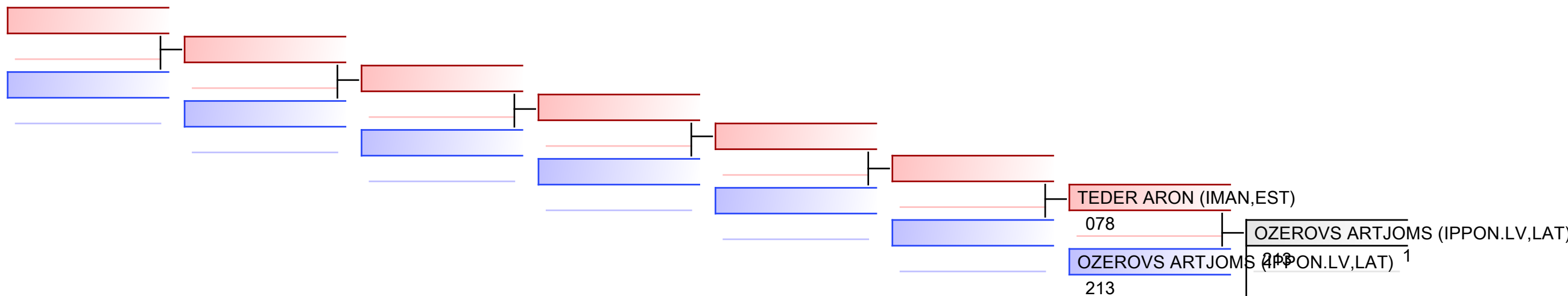

REPECHAGE: (1)

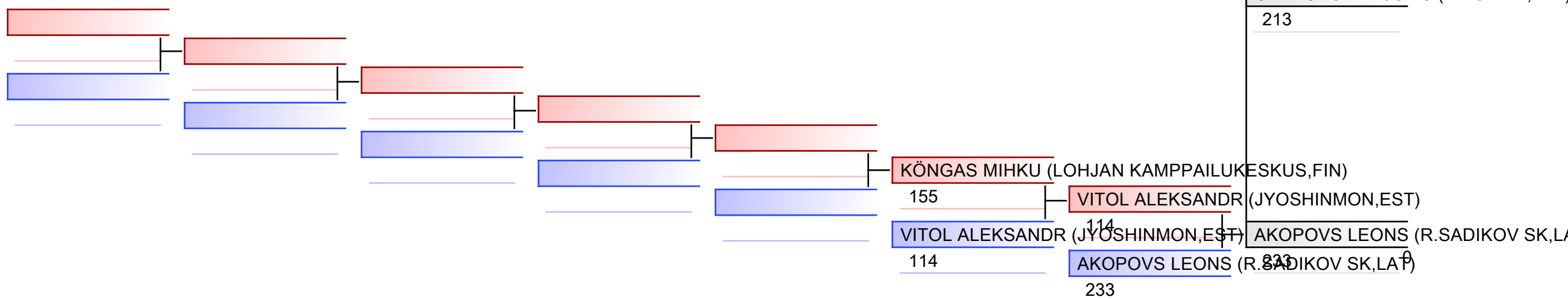

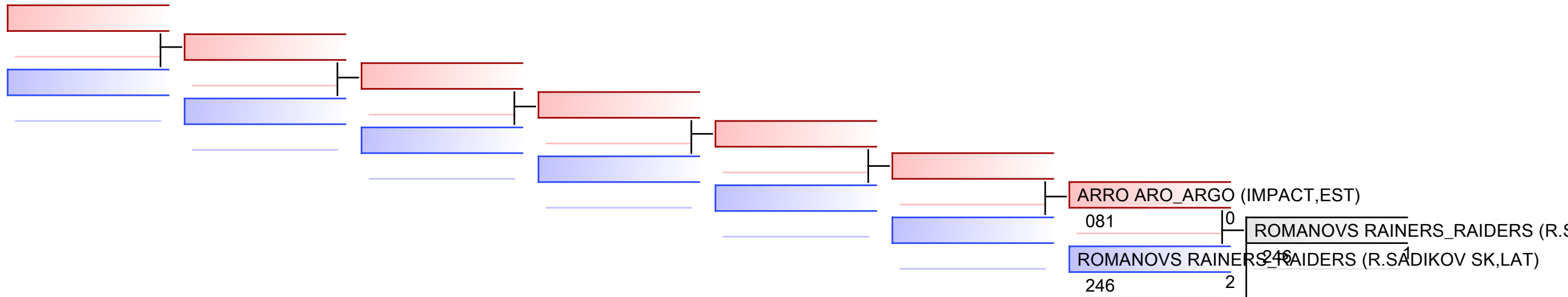

REPECHAGE: (1)

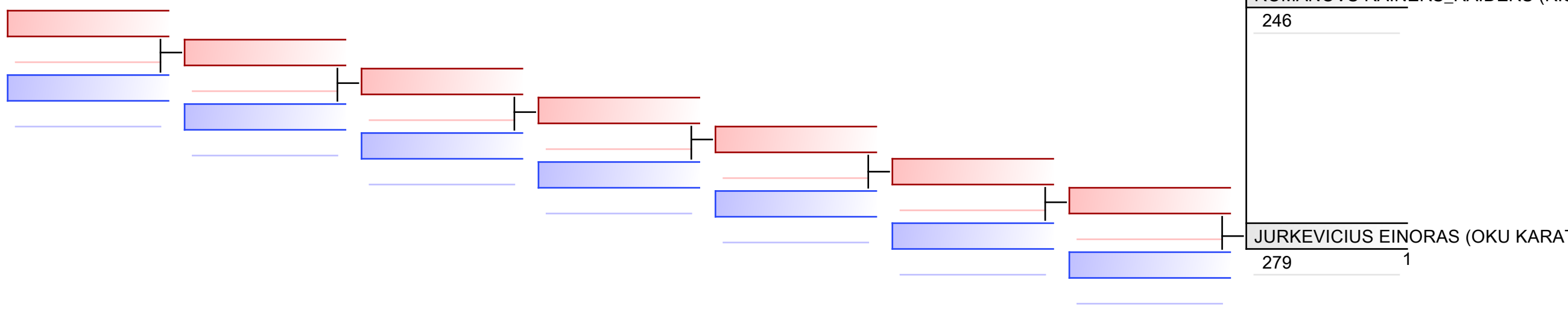

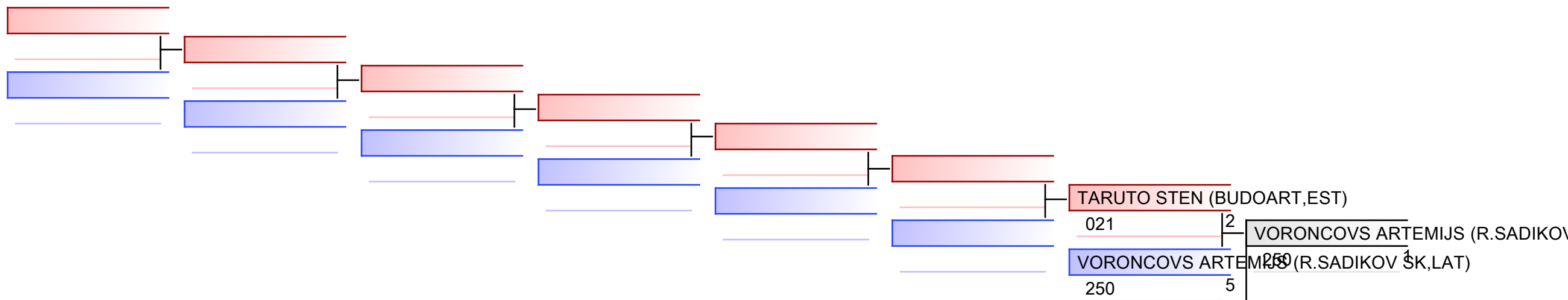

REPECHAGE: (1)

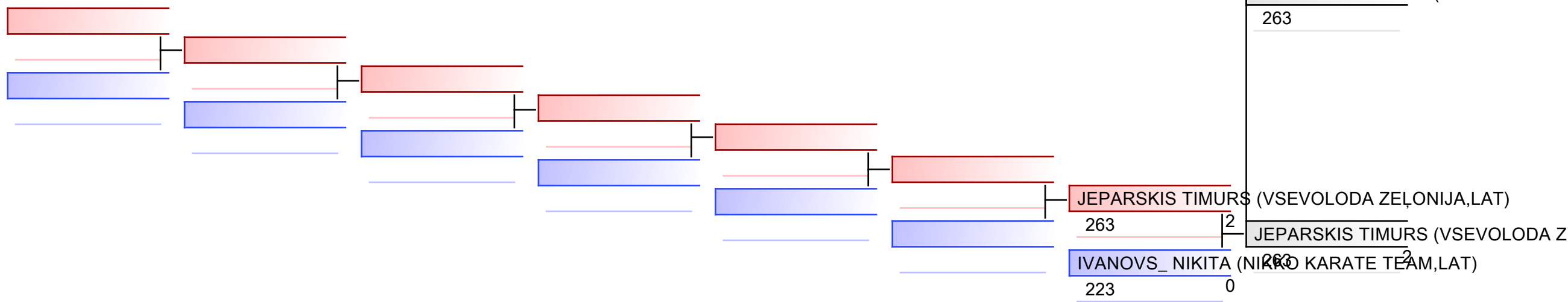

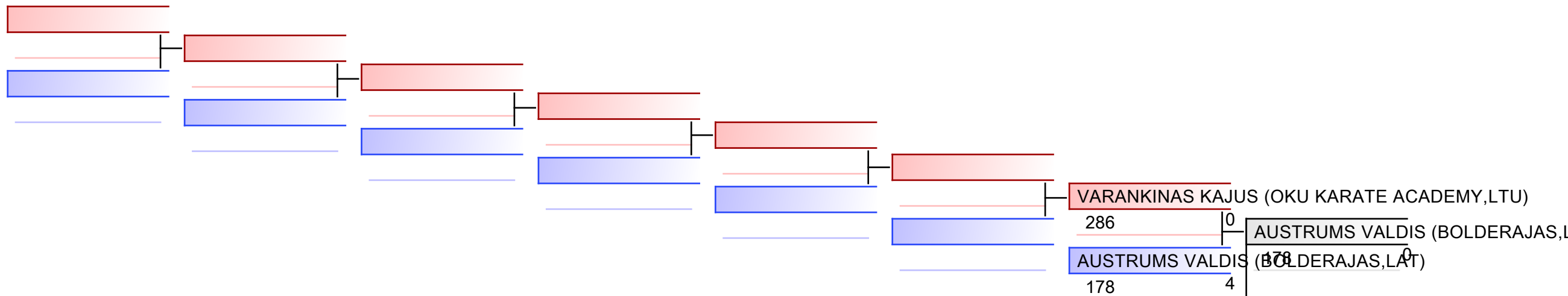

REPECHAGE: (1)

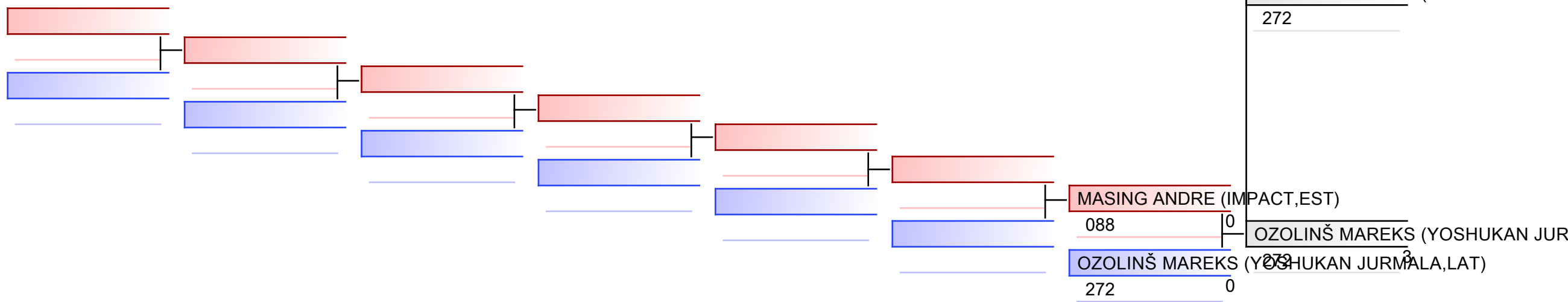

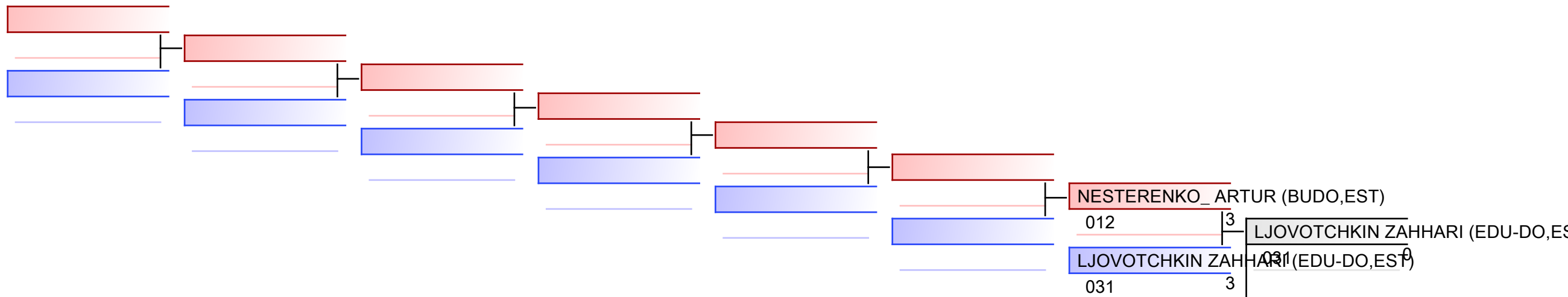

REPECHAGE: (1)

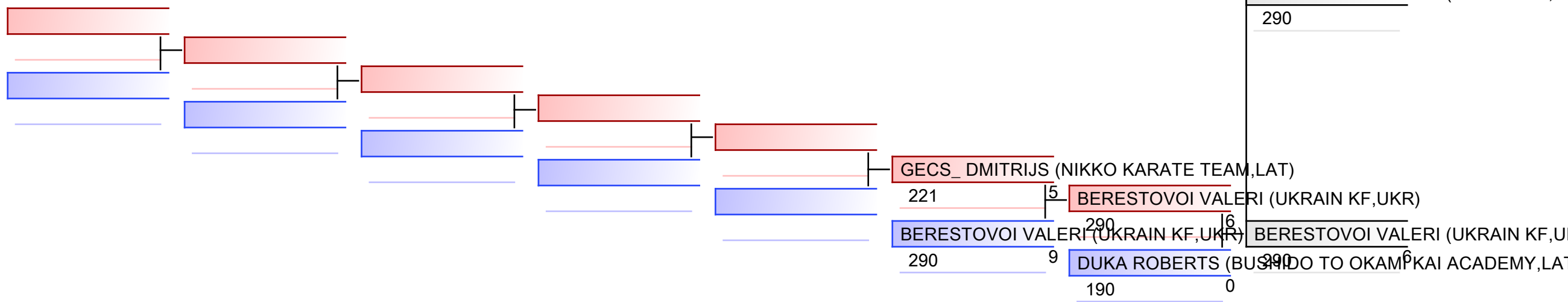

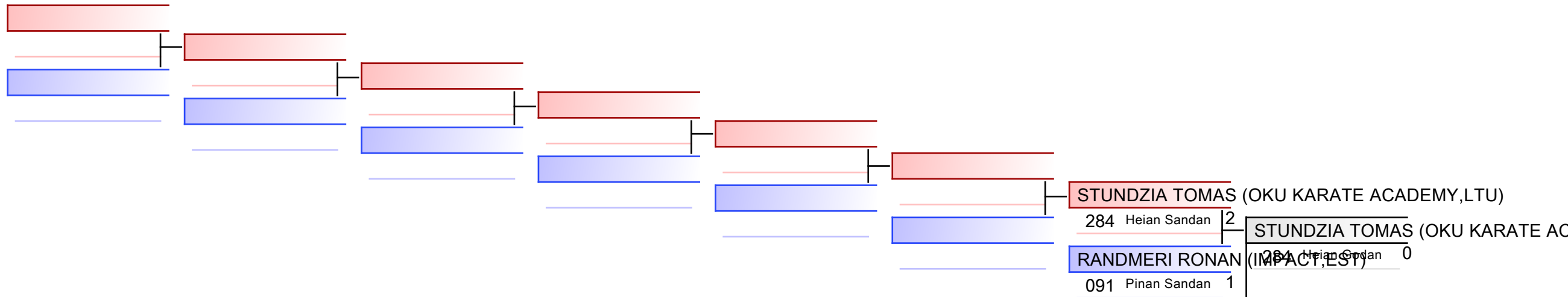

REPECHAGE: (1)

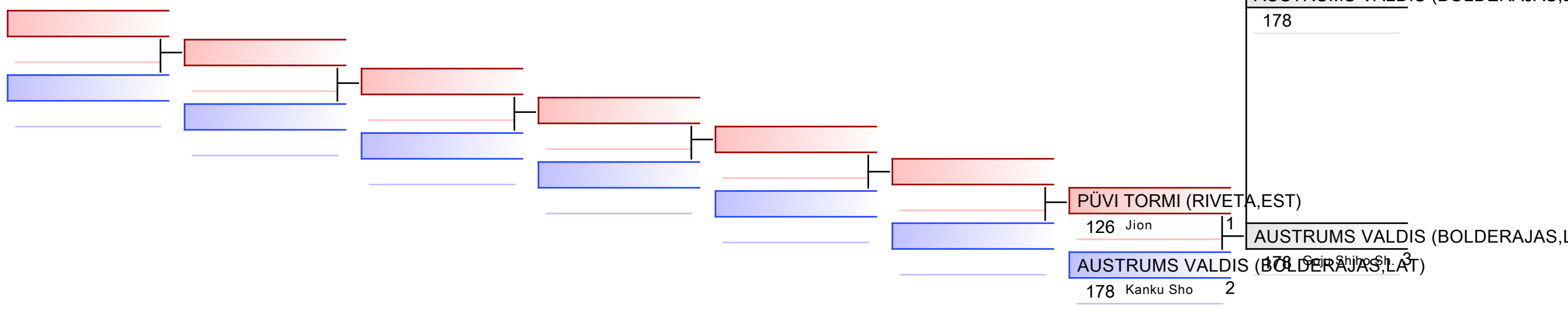

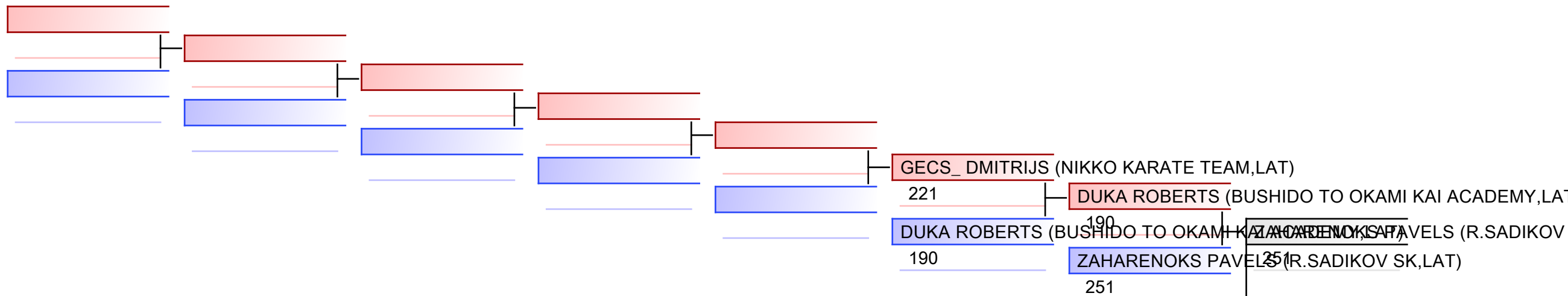

REPECHAGE: (1)

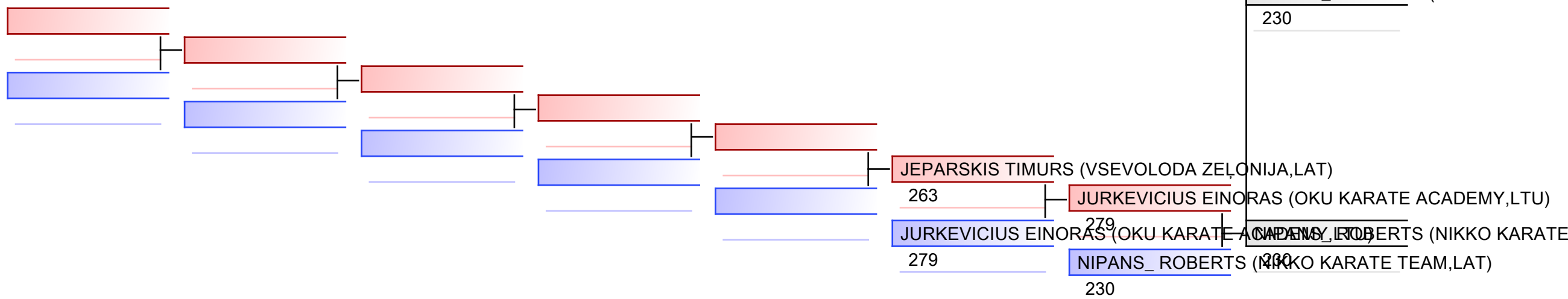

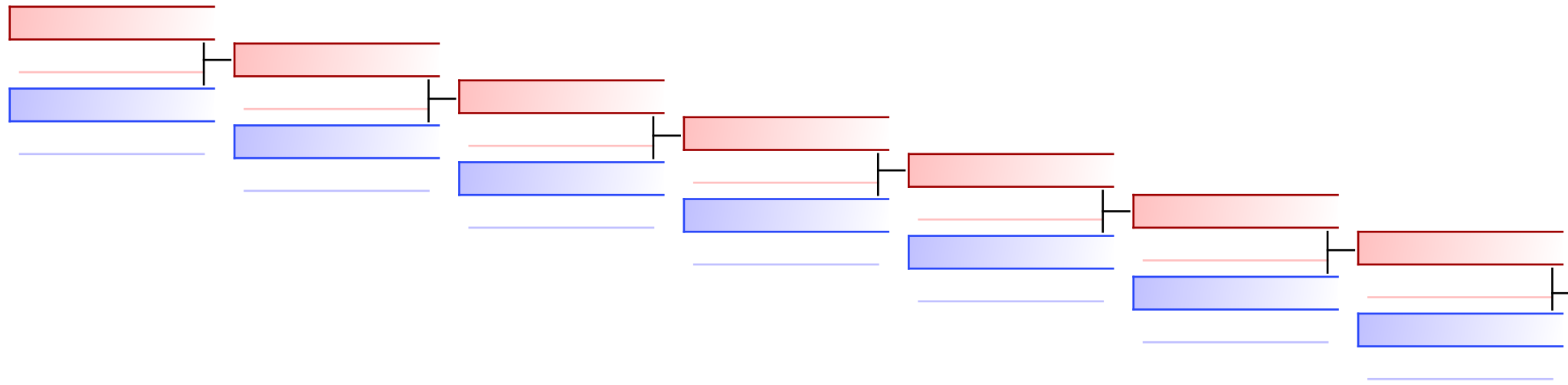

VOLKOV_ DENISS (NIKKO KARATE)	
232	0

REPECHAGE: (1)

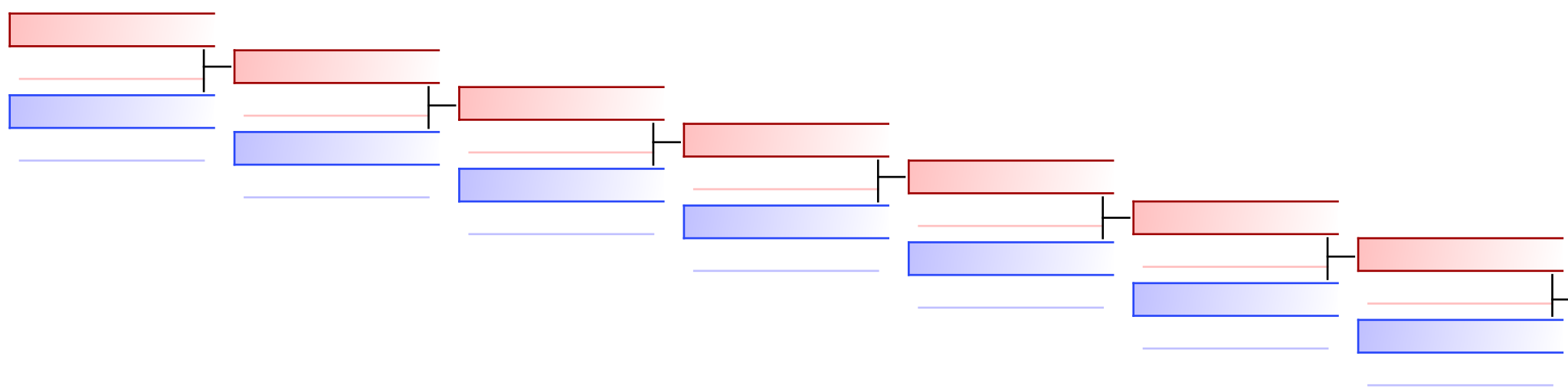

DROZD EGOR (EDU-DO,EST)	
027	

DROZD EGOR (EDU-DO,EST)	
027	3

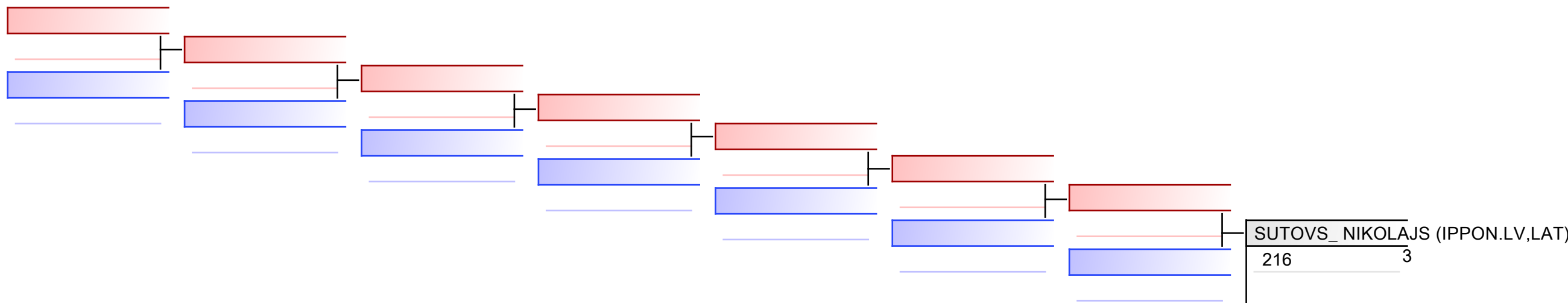

REPECHAGE: (1)

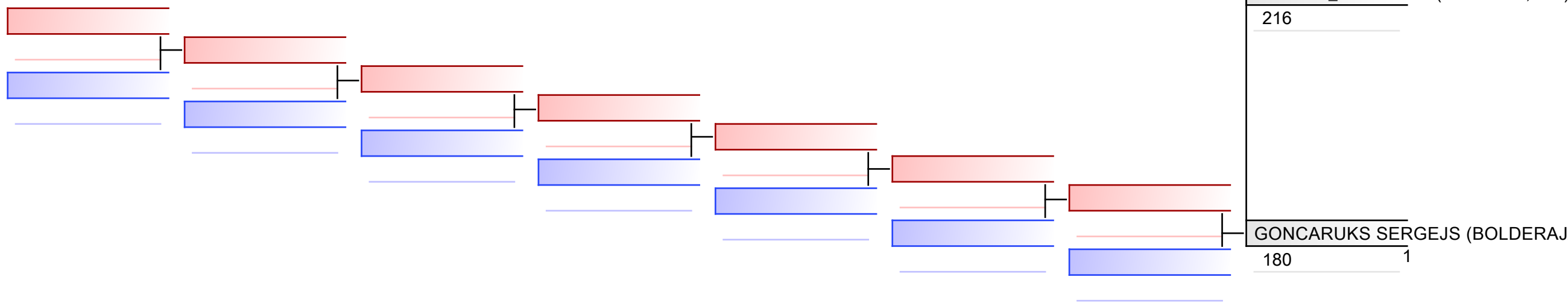

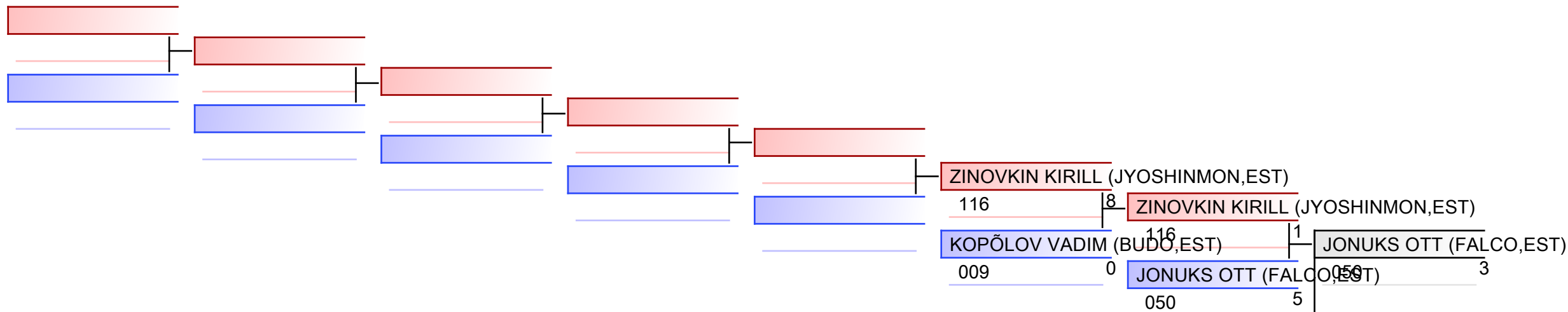

REPECHAGE: (1)

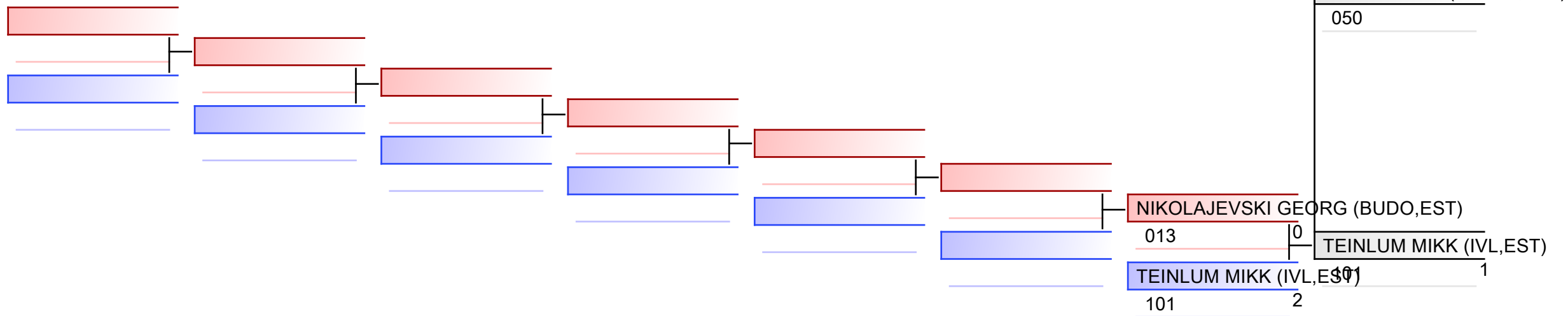

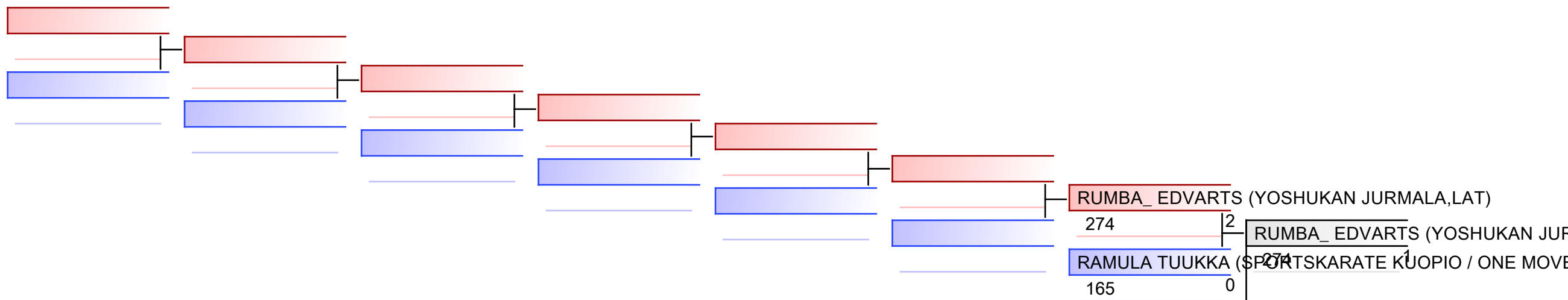

REPECHAGE: (1)

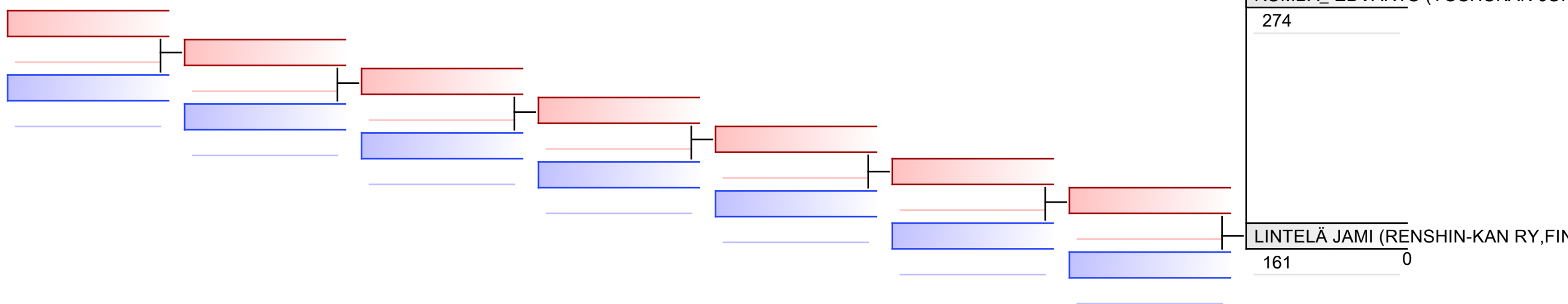

M U16 -70 kg

Budo Cup 2022

Tatami
3 18:10

Pool
1

(c)sportdata GmbH & Co KG 2000-2022(2022-05-15 00:23) -WKF Approved- v 9.8.7 build 3 (2020-09-25) License: Estonian Karate Federation (expire 2022-11-29)

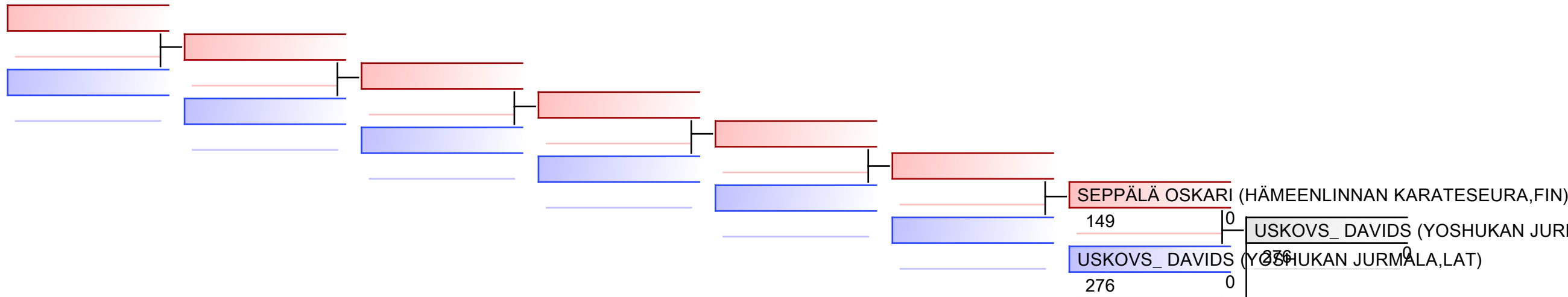

REPECHAGE: (1)

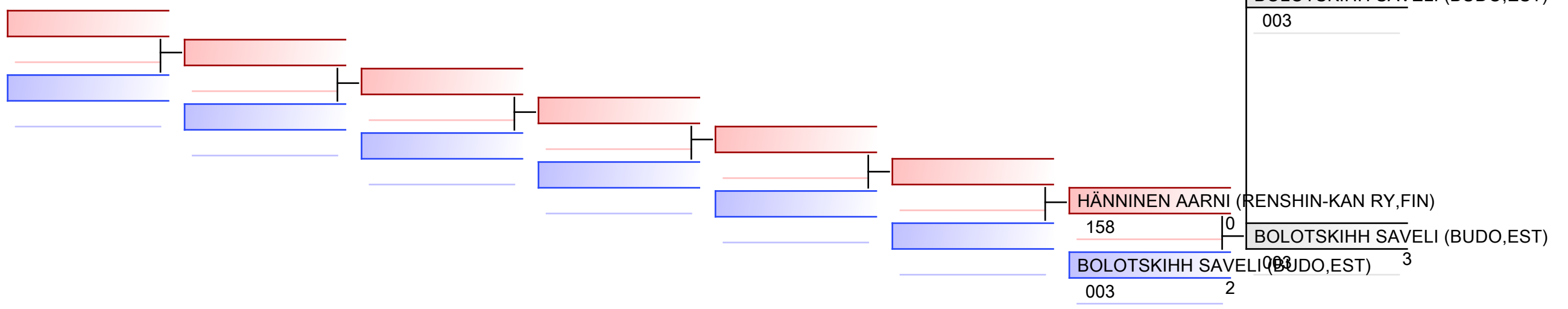

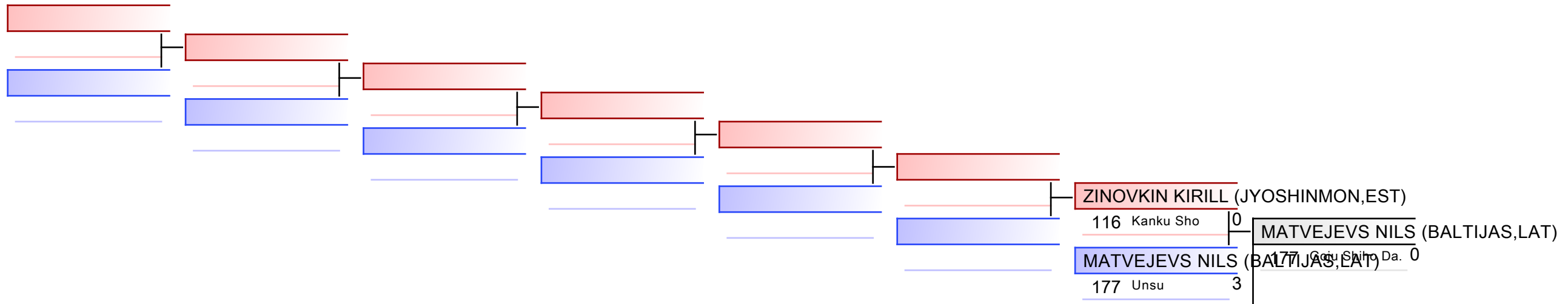

REPECHAGE: (1)

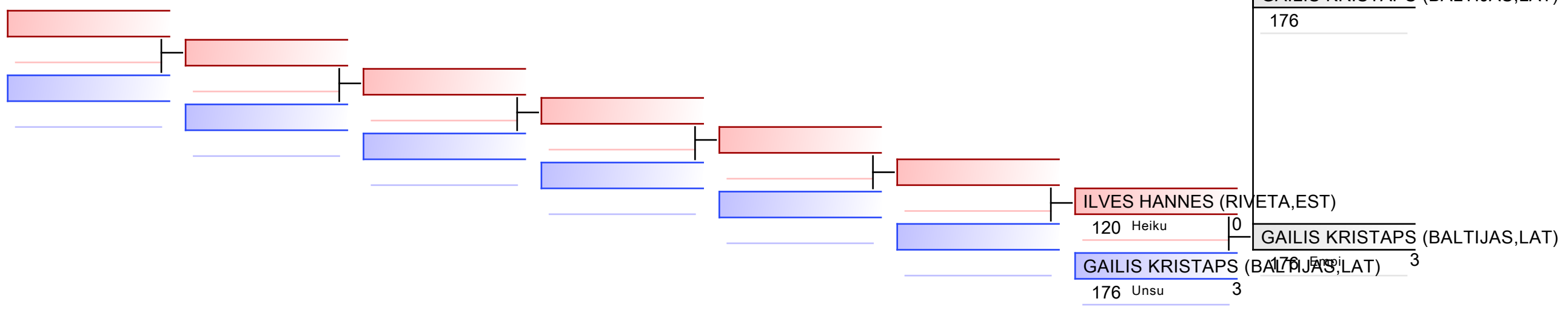

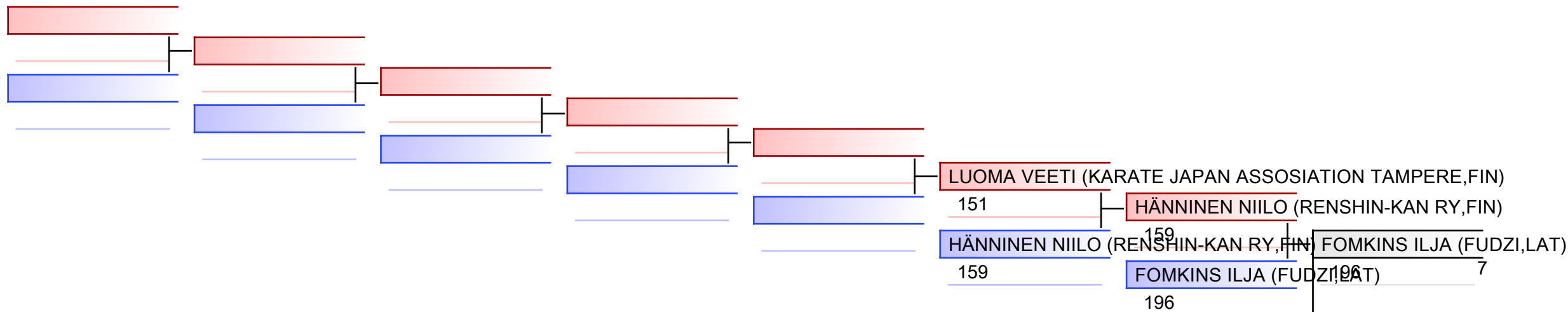

REPECHAGE: (1)

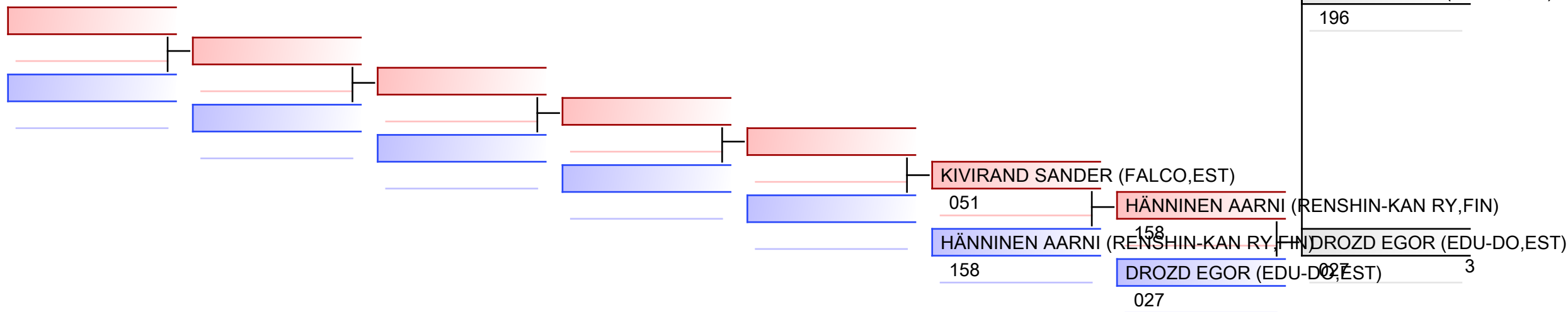

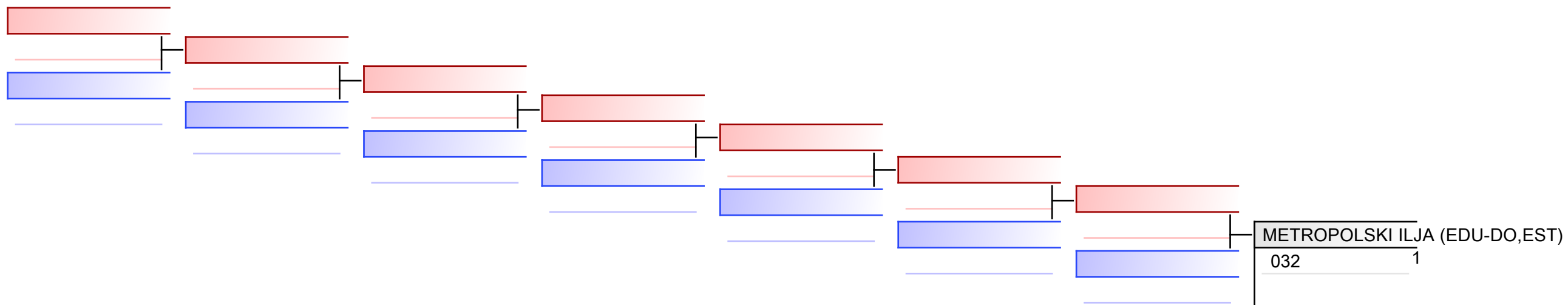

REPECHAGE: (1)

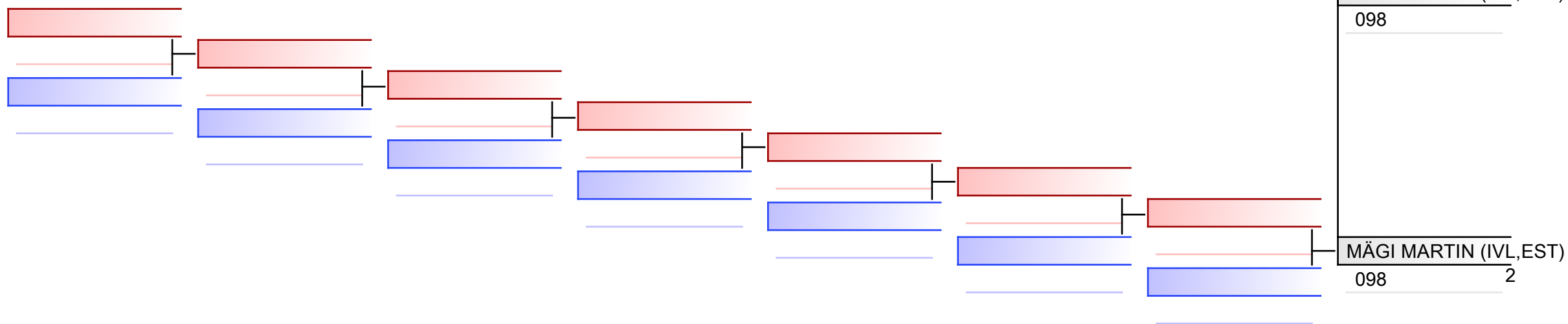

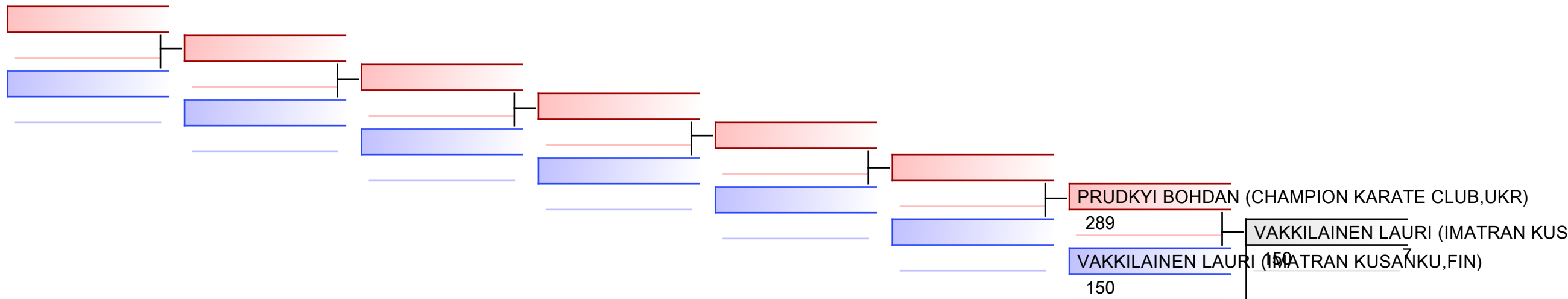

REPECHAGE: (1)

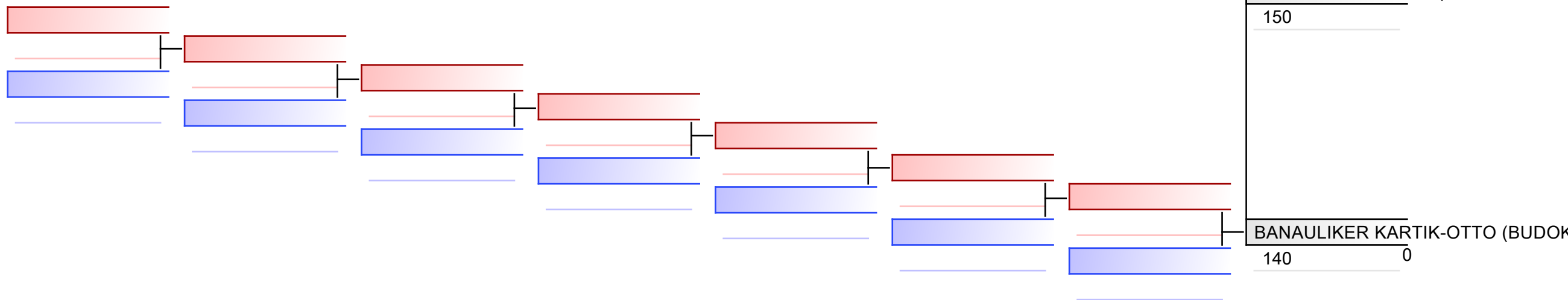

M U18 -76 kg

Budo Cup 2022

Tatami
1 19:35

Pool
1

(c)sportdata GmbH & Co KG 2000-2022(2022-05-15 00:23) -WKF Approved- v 9.8.7 build 3 (2020-09-25) License: Estonian Karate Federation (expire 2022-11-29)

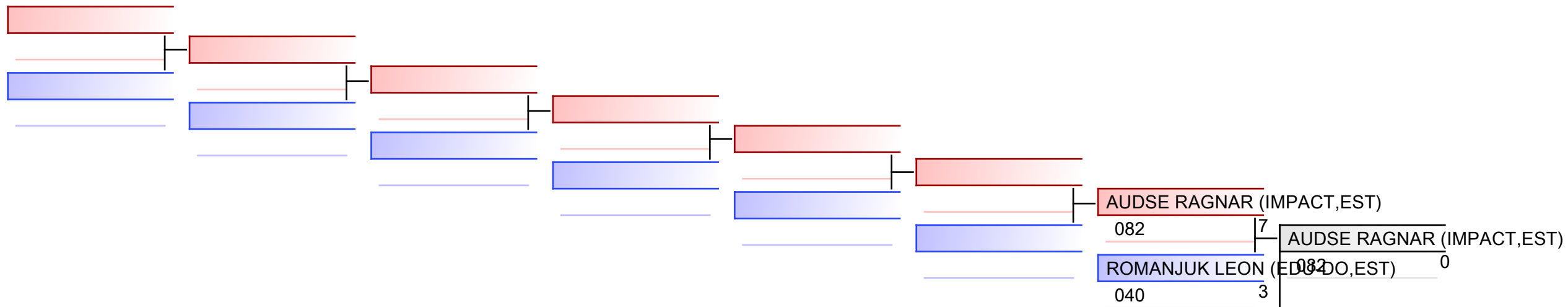

REPECHAGE: (1)

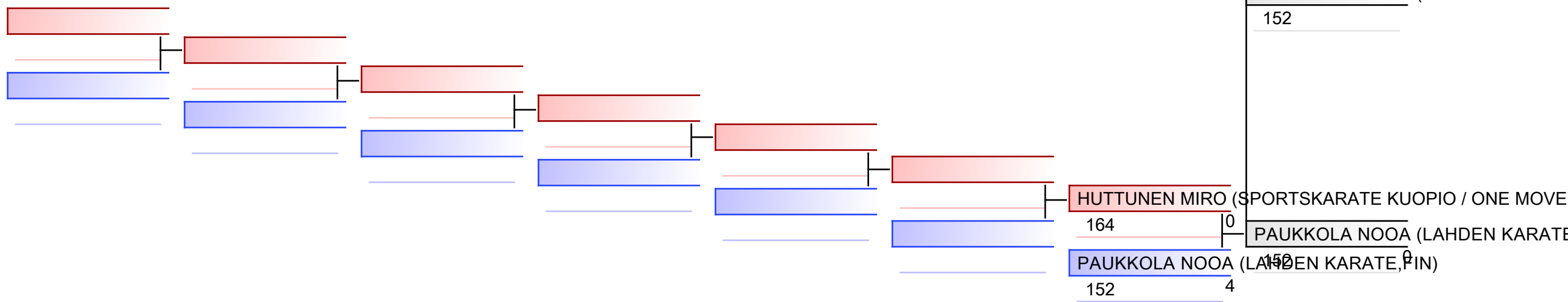

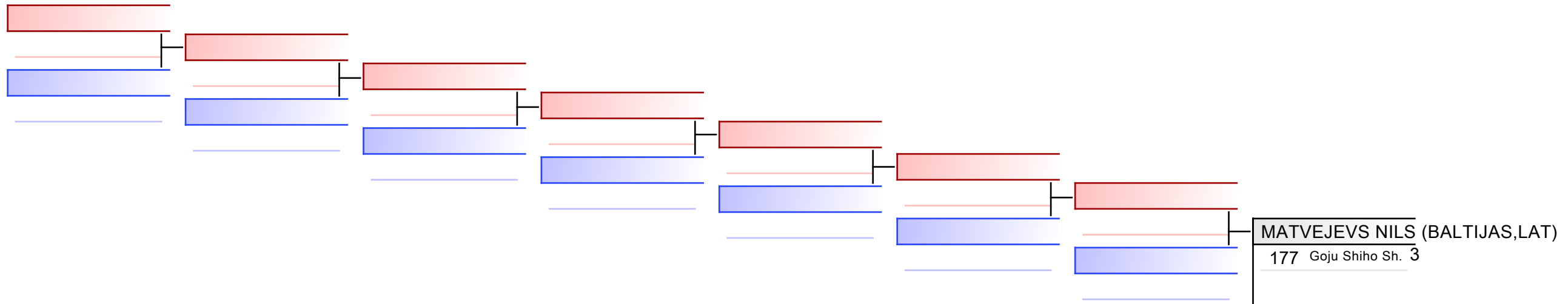

REPECHAGE: (1)

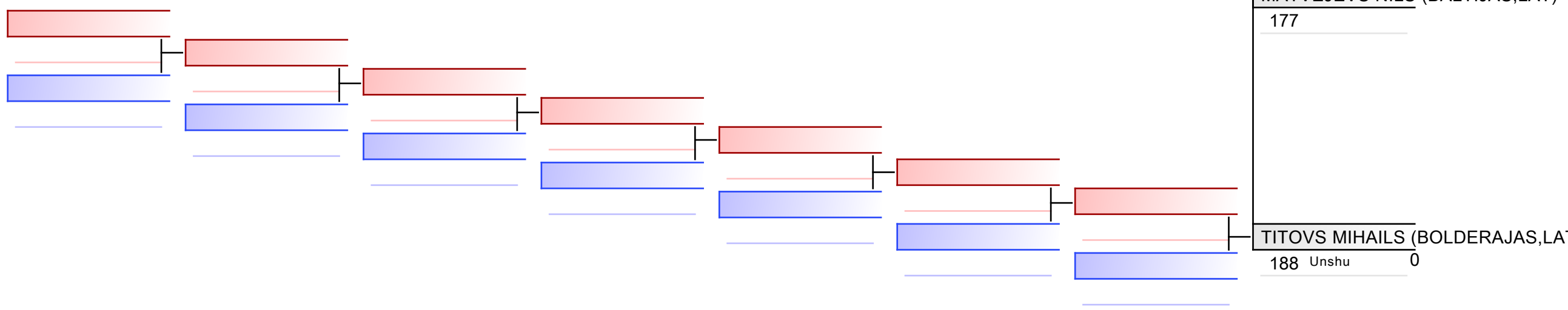

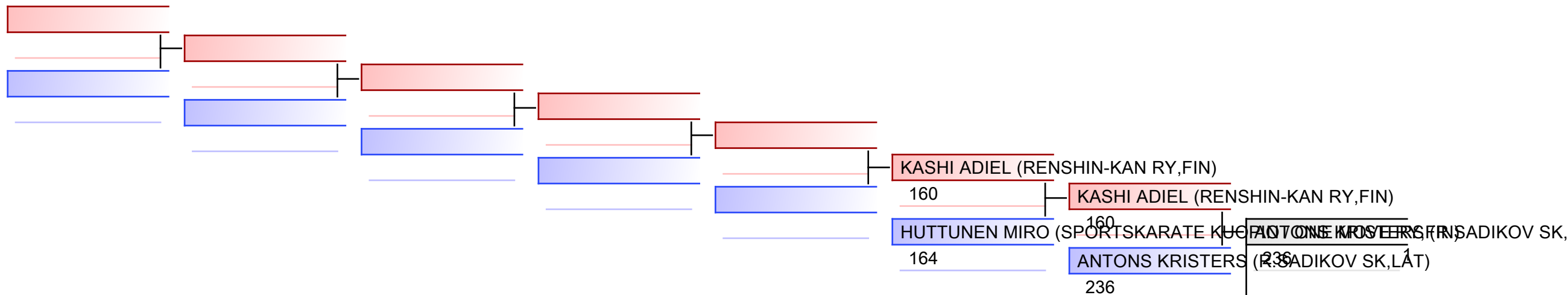

REPECHAGE: (1)

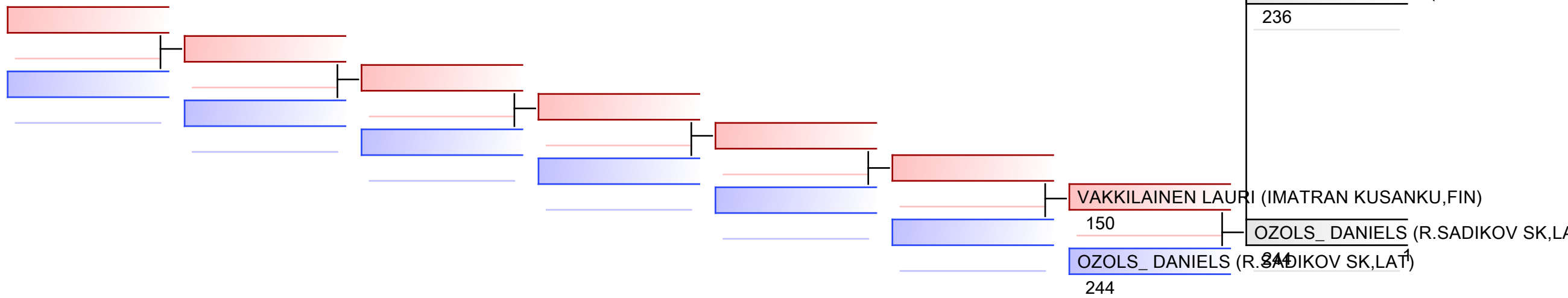

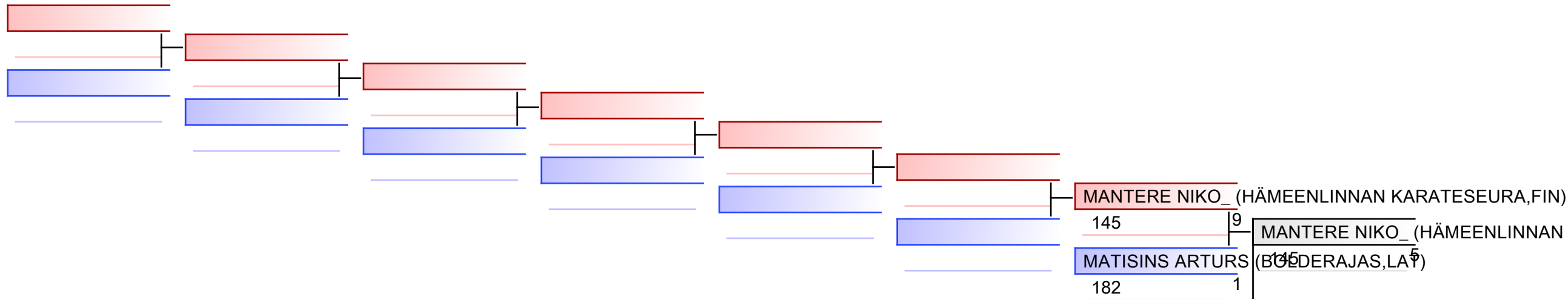

REPECHAGE: (1)

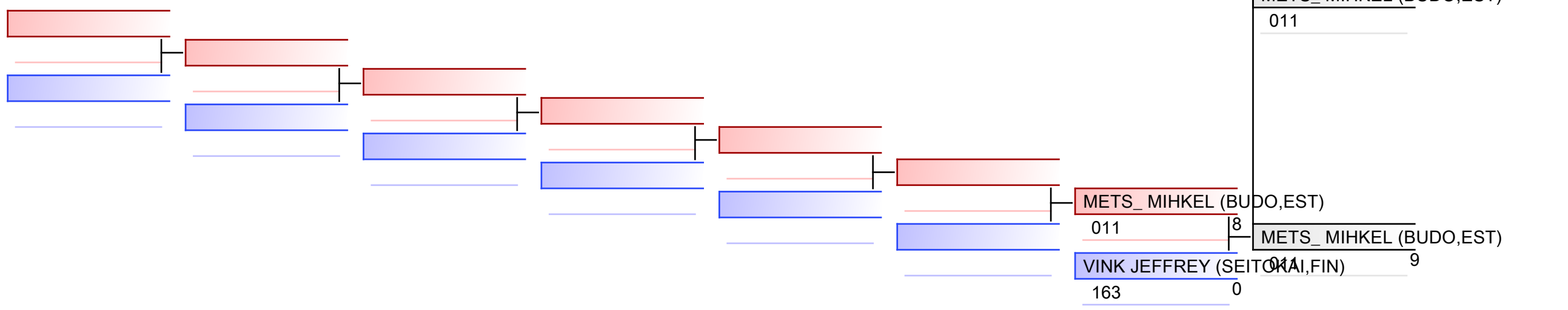

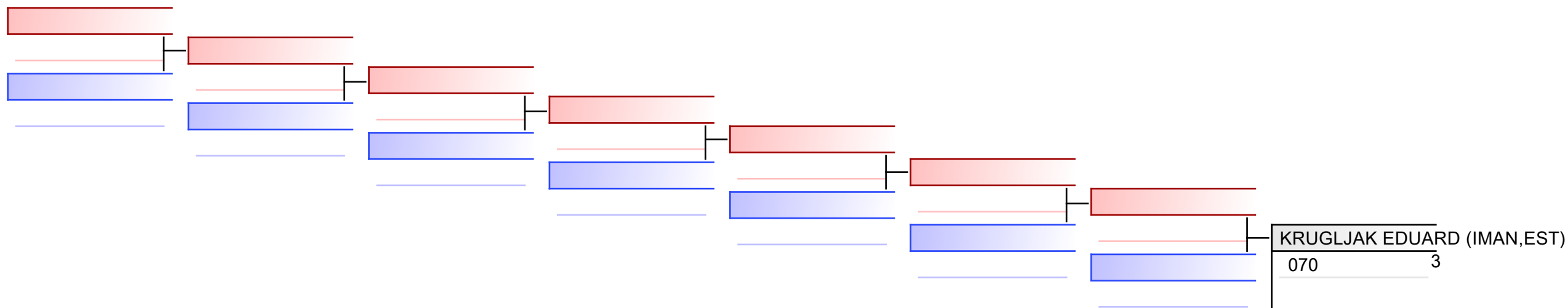

REPECHAGE: (1)

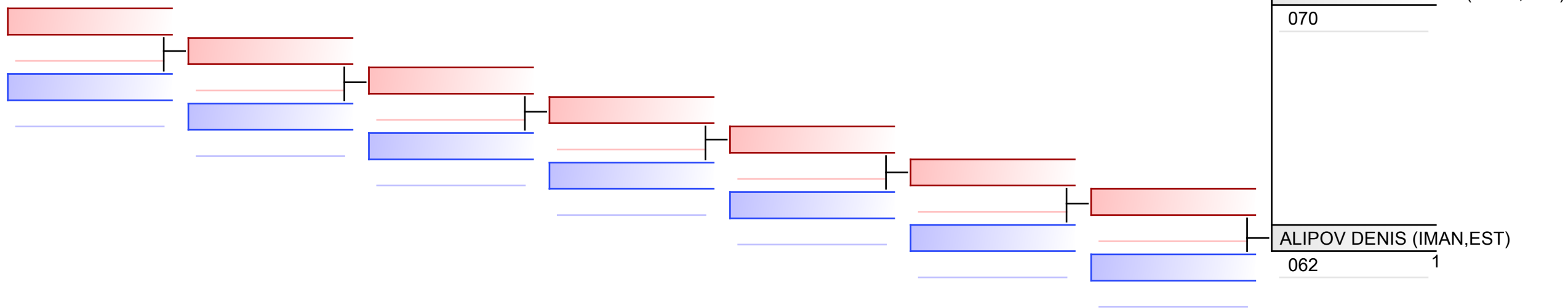

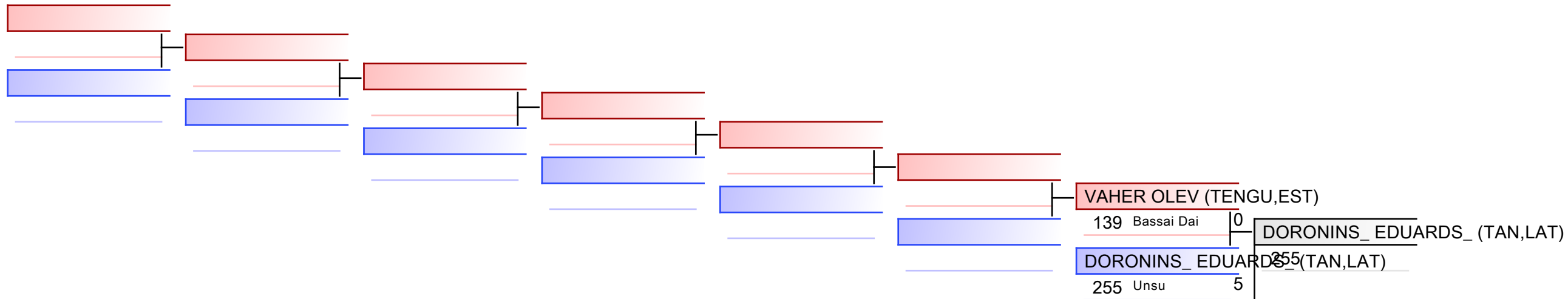

REPECHAGE: (1)

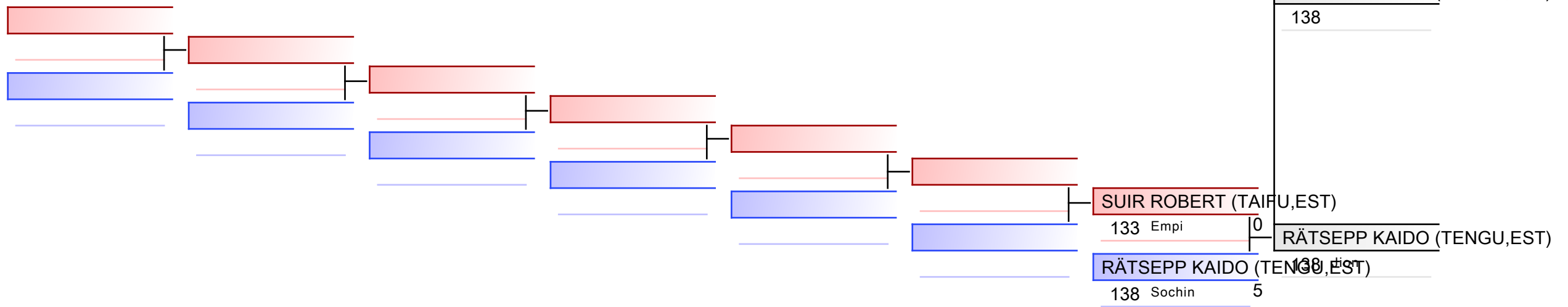

Male Open
Budo Cup 2022

Tatami
2 20:45

Pool
1

(c)sportdata GmbH & Co KG 2000-2022(2022-05-15 00:23) -WKF Approved- v 9.8.7 build 3 (2020-09-25) License: Estonian Karate Federation (expire 2022-11-29)

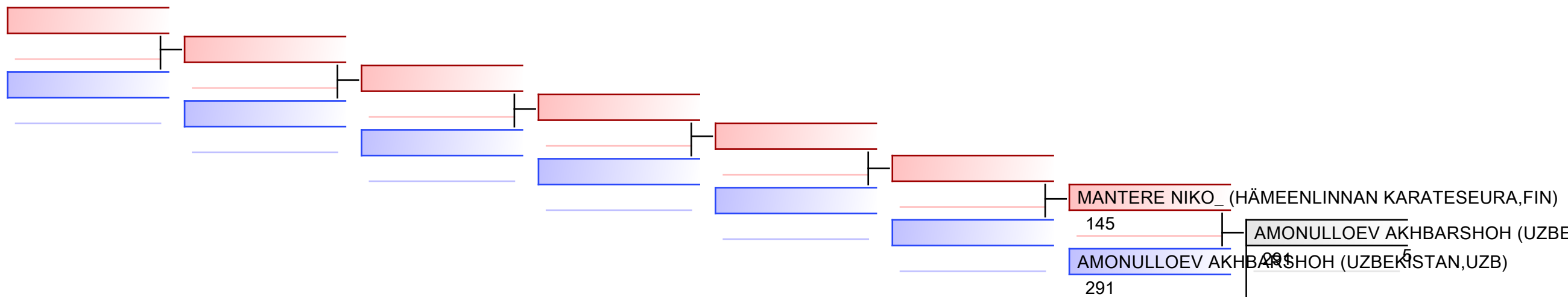

REPECHAGE: (1)

